



PIM(Pulse Input Module)
MIM-B16N

Air Conditioner installation manual

imagine the possibilities

Thank you for purchasing this Samsung product.

DB68-04502A-02

SAMSUNG





Contents

Before installation

Safety Precautions	3
Accessories	4
Viewing the Parts	5
PIM System Architecture	8



Installing the product

Installing the PIM	9
Setting the PIM	15
PIM Menu Description.....	16



Safety Precautions

This installation manual describes how to install the PIM. For installation of other optional accessories, refer to the appropriate installation manual.

 WARNING	Hazards or unsafe practices that may result in severe personal injury or death .
 CAUTION	Hazards or unsafe practices that may result in minor personal injury or property damage .

01 BEFORE INSTALLATION

WARNING





- ▶ Read carefully this installation manual before installation and check if the PIM is installed correctly after installation.
- ▶ Do not attempt to install or repair this PIM by yourself.
- ▶ This PIM contains no user-serviceable parts.
Always consult authorized service personnel for repairs.
- ▶ When moving, consult authorized service personnel for disconnection and installation of the PIM.
- ▶ Ensure that the wall is strong enough to support the weight of the PIM.
- ▶ Must install the PIM with rated power supply.
- ▶ The PIM must be installed according to the national electrical rules by an installation specialist.
- ▶ If you wish to uninstall the PIM, consult an authorized installation center.

CAUTION

- ▶ Do not use inflammable gases near the PIM.
- ▶ Do not install the PIM in a location where it will come into contact with combustible gases, machine oil, sulphide gas, etc.
- ▶ Avoid locations where acid/alkali solution or special spray is used.
- ▶ Choose a location that is dry and sunny, but not exposed to direct sunlight. Suitable temperature is between 0°C(32°F) and 39°C(102.2°F).
- ▶ Do not spill water into the PIM.
- ▶ Do not apply tensile strength to the cable to avoid cable damage.
- ▶ Do not press the buttons with a sharp object.
- ▶ Do not connect the power cable to the control terminal.
- ▶ If the PIM is installed in a hospital or other special places, it should not affect other electronic devices.

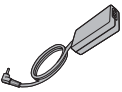
Accessories

Make sure you have each item. Supplied items may vary depending on your country or service provider. The type and quantity may differ depending on the specifications.

Item	PIM	Adapter	Power cable	M4x16 Screw	Installation manual	Cable tie
Quantity	1	1	1	6	1	1
Shape						



- The PIM must be installed by a trained installer.
- Ensure the main power is turned off before installing the PIM.
- Be sure to use adapter and power cable we provide.
- The power cable and the communication cable must be installed according to the national electrical wiring regulations. (Use 2C x 0.75mm² communication cable.)

Viewing the Parts

Main Parts

PIM Exterior

LCD Display
Shows current time and consumption by channel. Various menus will be displayed depending on button input.

LCD Operation button
There are 4 buttons [Menu, ▼(Down), ▲(Up), Set] and you can access, move and check the menu.

LED Indicator
Checks the status using 14 LEDs such as Power, COM1 TX/RX, Signal, COM2 TX/RX and Check.

PIM Bottom cover
Unfasten 2 screws on the bottom and separate the bottom cover from PIM. Then check cable connection part.

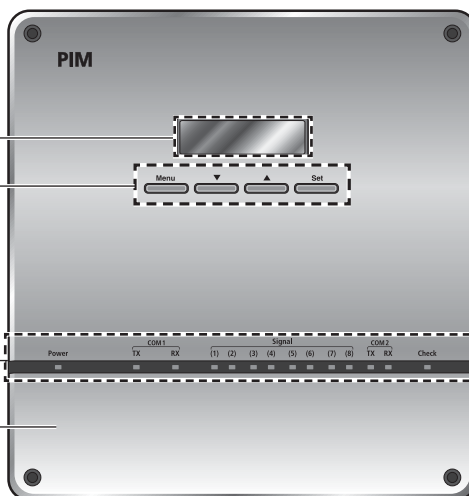

01 BEFORE INSTALLATION

Explanation of LED Indicator

Item	Name	Status
Power	Power indicator	Turns blue when the power is supplied.
COM1 TX/RX	Data transmission/reception with DMS indicator	Blinks in orange during the normal transmission/reception.
Signal (1)~(8)	Input pulse indicator	Blinks in orange when a normal pulse is input from the meter.
COM2 TX/RX	Reserved	Reserved
Check	Error indicator	Blinks in orange when the error occurs. (It will be off when the error is cleared.)

Viewing the Parts

PIM Cable Connection Part

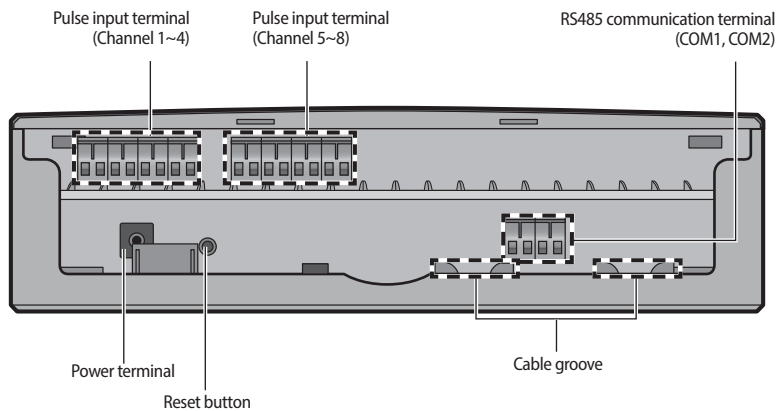

Name	Description
Pulse input terminal (CH1~CH8)	Terminal that the pulse from Meter is inputted (Channel1~Channel8) ※ Dry contact must be connected.
Power terminal	Terminal to connect PIM adapter
Reset button	Button used to reset PIM
RS485 Communication terminal	COM1: Connection terminal for RS485 communication with DMS2 ※ COM2 : Not in use (It will be used for MODBUS in the future)
Cable groove	Groove for arranging cables



PIM Interior

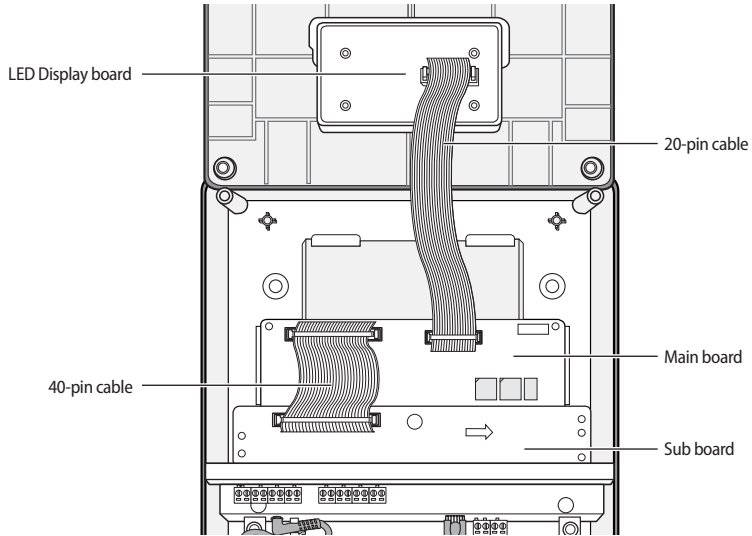

01 BEFORE INSTALLATION

Product Dimensions

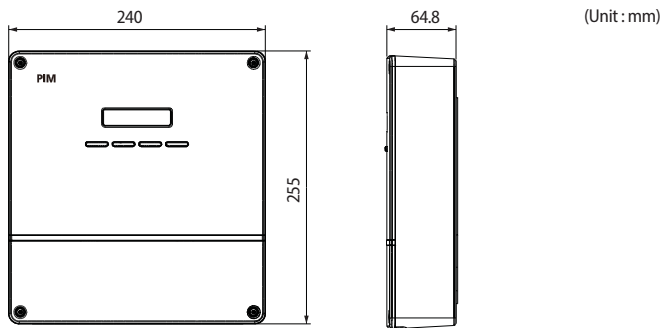

English-7



PIM System Architecture

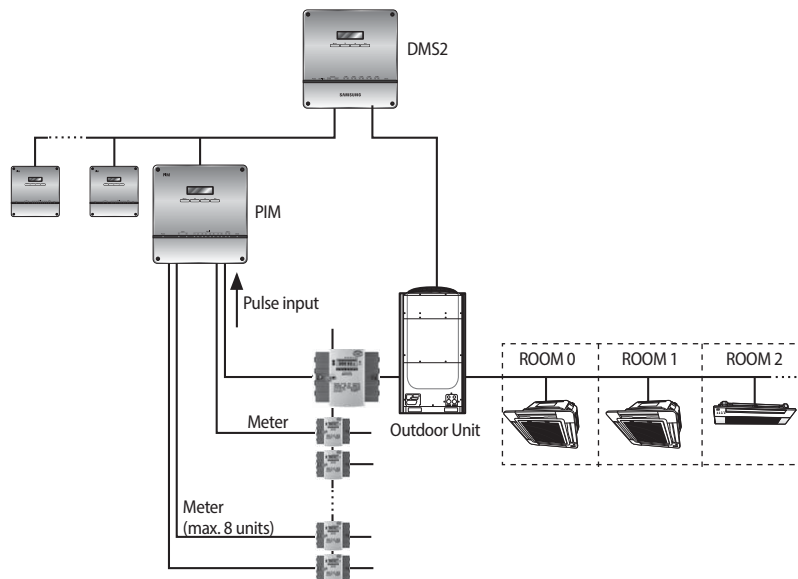

- ▶ Maximum 8 PIM units can be connected to DMS2.
- ▶ Maximum 8 meter(Power/Gas/Water) can be connected to PIM.



Installing the PIM

Installing the PIM on the Wall

1. Separate the installation plate on the rear side of PIM.
2. Fix the installation plate on the wall using 4 screws.
3. Hang the PIM on the groove which is on the top of the installation plate.
4. Open the bottom cover and fix the installation plate and PIM using 2 screws.
 - Depending on the installation environment, open the top cover and fix PIM using assistant holes. (Screws for assistant hole are not provided.)
5. If you install PIM inside of the wall or wiring from the rear side is needed, use wiring groove on the bottom of PIM.

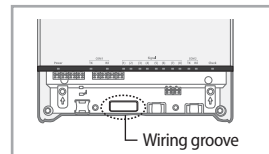
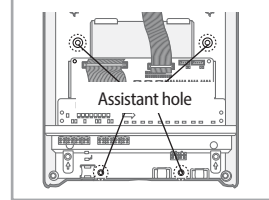
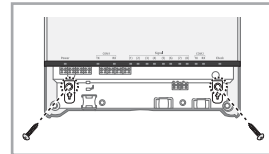
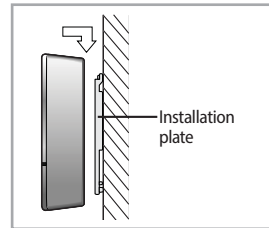
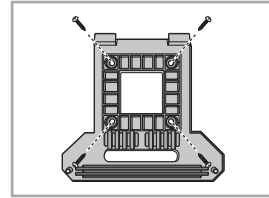
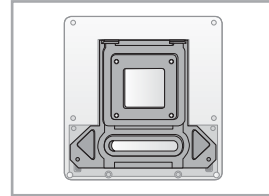

• To prevent breakdown and damage of PIM and for safe usage, it is recommended to install PIM on the wall.



Installing the PIM

Connecting a Meter, PIM and DMS

Connecting a Meter and PIM

1. Unfasten the 2 screws on the bottom of the PIM front cover. Hold the bottom 2 sides of the PIM and push downwards to slide open the cover.

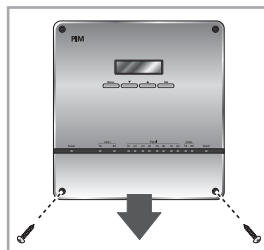

2. Connect the adapter to the power terminal.
 - Arrange the adapter as shown in the figure.

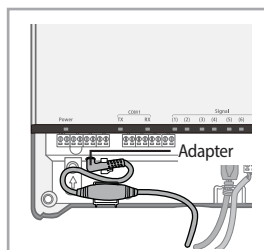

3. Connect PIM and a Meter as many as you want. In this step, use communication cable and 8 terminal blocks which are attached to the pulse input terminal of PIM.
 - For the communication cable connection instruction of a Meter or additional setting instruction, refer to the installation manual of a Meter.
 - Connect the communication cable considering the polarity. [Left:(+), Right:(-)]

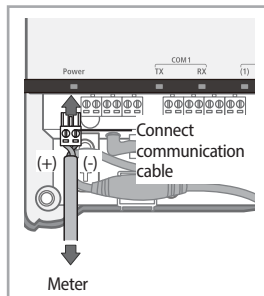

- Maximum 8 meter(Power/Gas/Water) can be connected to 1 PIM.
- Use 2Cx0.75mm² communication cable.



Connectable Meter with PIM

Meter without Separate External Output

- ▶ If the pulse constant(Wh/Pulse or m³/Pulse or L/Pulse) value is an integer, connection is possible.
e.g. Pulses per kWh : 1,000 converted to → 1Wh/Pulse, Connection is possible!
e.g. Pulses per kWh : 10,000 converted to → 0.1Wh/Pulse, Connection is not possible!

Meter with Separate External Output

- ▶ Connect according to the pulse output specification.

Meter must have more than 3ms Delay Between the First Pulse Input and the Next Pulse

Waveform of CH1~8

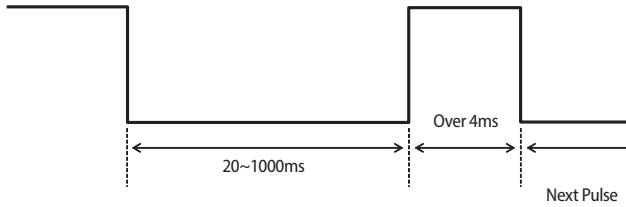

Limit of Connectable Meter

- Pulse constant range
 - Power : 1Wh/Pulse ~ 10,000Wh/Pulse
 - Gas : 0.001m³/Pulse ~ 10m³/Pulse
 - Water : 1L/Pulse ~ 10,000L/Pulse
- Pulse width range: 20~1000ms.

Installing the PIM

Connecting PIM to DMS2

1. Connect 'COM1' terminal of PIM and DMS 2 terminal block with communication cable.
 - Pay special attention about the polarity when connecting RS485 communication.
(A of PIM ↔ A of DMS, B of PIM ↔ B of DMS)

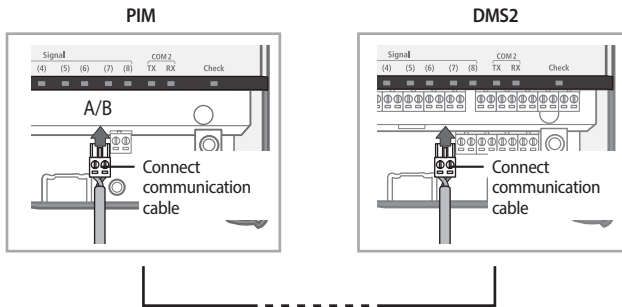

2. Close the bottom cover and fix it using 2 screws.

▶ When execute tracking with PIM which connected to DMS2

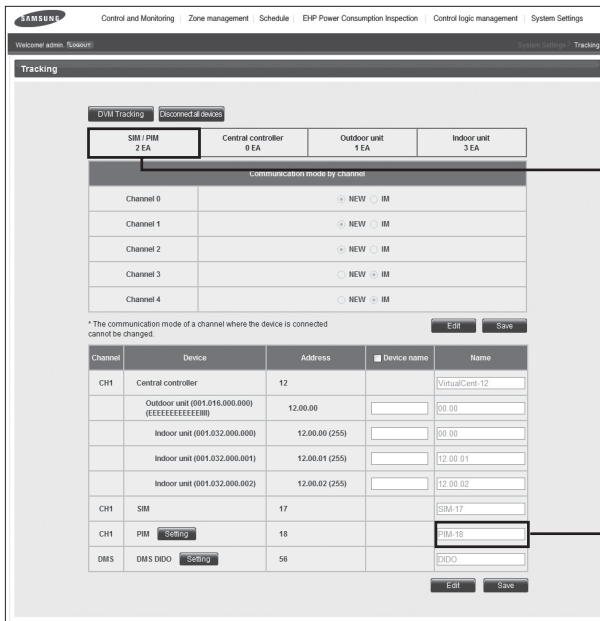

* For the further information about tracking, refer to the DMS2 user manual.

- ▶ If PIM is connected to DMS2, PIM setting through DMS2 web is possible.

PIM Channel	Meter Value	Meter Type	Pulse rate	Channel Status
18.1	644.0	Electricity	0	Whip Enable
18.2	644.0	Water	0	Whip Enable
18.3	644.0	Gas	0	Whip Enable
18.4	644.0	Electricity	0	Whip Enable
18.5	644.0	Electricity	0	Whip Enable
18.6	644.0	Electricity	0	Whip Enable
18.7	644.0	Electricity	0	Whip Enable
18.8	644.0	Electricity	0	Whip Enable

SIB / PIM Channel	Name	CT proportion	Meter Type	Meter Value	Unit
17.1	17.1	1	Electricity	520.0	kWh
17.2	17.2	1	Electricity	520.0	kWh
17.3	17.3	1	Electricity	520.0	kWh
17.4	17.4	1	Electricity	520.0	kWh
17.5	17.5	1	Electricity	520.0	kWh
17.6	17.6	1	Electricity	520.0	kWh
17.7	17.7	1	Electricity	520.0	kWh
17.8	17.8	1	Electricity	520.0	kWh
18.1	18.1	1	Electricity	644.0	kWh
18.2	18.2	1	Water	644.0	m³
18.3	18.3	1	Gas	644.0	m³
18.4	18.4	1	Electricity	644.0	kWh
18.5	18.5	1	Electricity	644.0	kWh
18.6	18.6	1	Electricity	644.0	kWh
18.7	18.7	1	Electricity	644.0	kWh
18.8	18.8	1	Electricity	644.0	kWh

Installing the PIM

Installing more than 2 PIM Units to 1 DMS

1. Unfasten the 2 screws on the top of the PIM. Hold the top 2 sides of the PIM and pull it the cover upwards to open the cover.

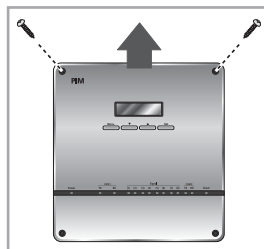

2. Set the PIM address using rotary switch of main PCB. (Default setting: 30H)
 - Rotary Switch #1 : Not in use
 - Rotary Switch #2 : 0 ~ F (30H ~ 3FH)

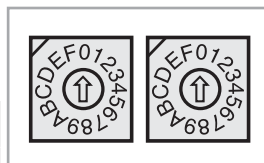

Rotary Switch #1	Communication Address	Rotary Switch #2	Communication Address	DMS2 Address
0	N/A	0	30H	16
1	N/A	1	31H	17
2	N/A	2	32H	18
3	N/A	3	33H	19
4	N/A	4	34H	20
5	N/A	5	35H	21
6	N/A	6	36H	22
7	N/A	7	37H	23
8	N/A	8	38H	* The PIM communication addresses on the left side (8~F) are assigned for system extension in the future. Therefore, do not set the addresses as they will not be recognized with a DMS2.
9	N/A	9	39H	
A	N/A	A	3AH	
B	N/A	B	3BH	
C	N/A	C	3CH	
D	N/A	D	3DH	
E	N/A	E	3EH	
F	N/A	F	3FH	

3. Close the top PIM cover and fix it using 2 screws.

Error Codes

Display	Explanation
E613	Error which occurs when there is no communication between DMS and PIM/SIM for 15 minutes.
E632	<ul style="list-style-type: none"> • Error which occurs when the pulse was input differently from the PIM setting. • (If the pulse was inputted at the value outside of 10 ms ~ 1500 ms range for more than 15 times or when high pulse was inputted for over 3 minutes)
E654	Memory Read/Write error.
E108	Error which occurs when same address was assigned to different devices.



Setting the PIM

Setting the PIM(Mandatory)

It is mandatory when you connect Meter and PIM.

Setting the Password

2.1 Password
Password Set

Set your P/W

■ : ■ : ■ : ■

Main menu → 2. Configuration → 2.1 Password.

- ▶ Default : 0000
- ▶ For the further information, refer to page 20.

Setting the Date/Time

Set Current Date
2010.01.05

Set Current Time
11:25:09(PM)

Main menu → 2. Configuration → 2.4 Date&Time

- ▶ For the further information, refer to page 24~25.
- ▶ The display above is an example.

Setting for the Connected meter type and pulse rate

Setting the meter type

2. Configuratuion
2.2 Meter Type

2.2 Meter Type
CH1:Power Meter

Main menu → 2. Configuration → 2.2 Meter Type

- ▶ For the further information, refer to page 22.

Setting the meter pulse rate

2. Configuratuion
2.3 Pulse Rate

2.3 Pulse Rate
CH1:00100Wh/P

Main menu → 2. Configuration → 2.3 Pulse Rate

- ▶ For the further information, refer to page 23.

PIM Menu Description

Menu Configuration

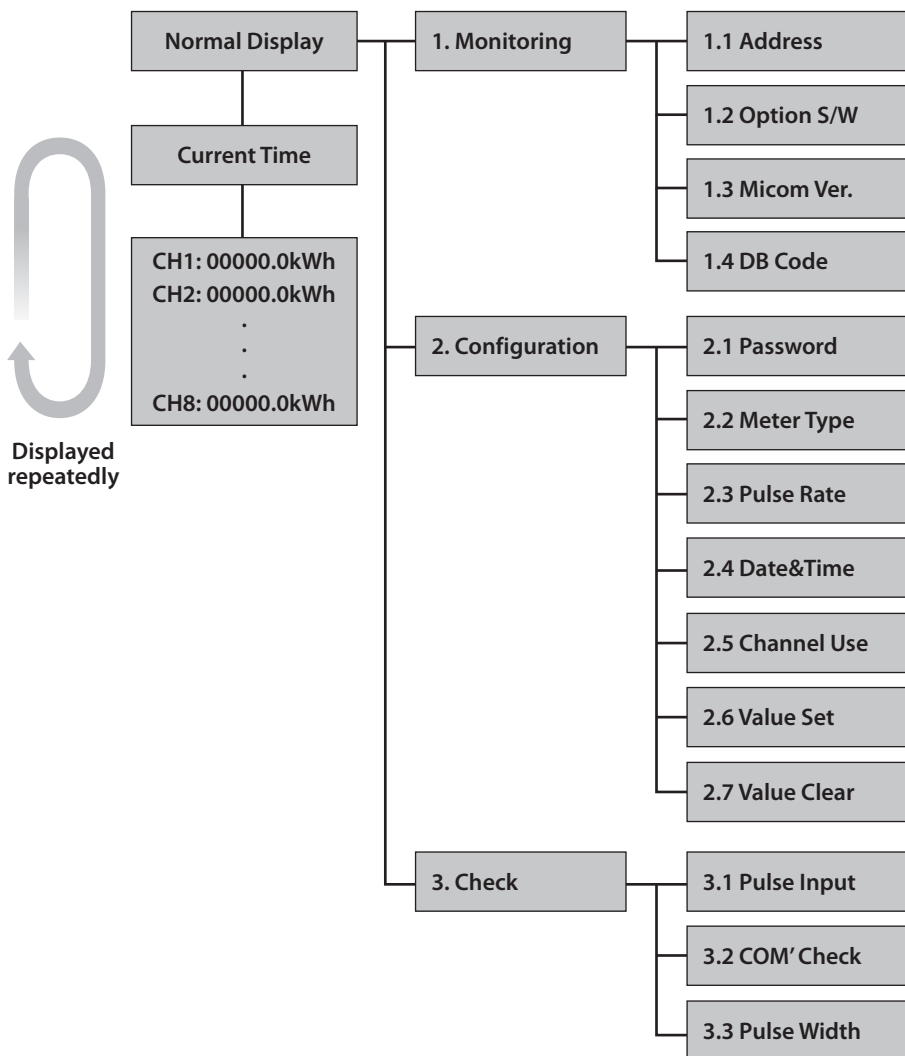



Normal Display

1. When the power is connected, current PIM address and software version will be displayed.
 - Example display: PIM address 58 30 FF
Software version DB91-01128A
 - "Address:58 30 FF" is an example. It is subject to change according to the setting.

Device Info.
Type:PIM

Device Info.
Addr.: 58 30 FF

Device Info.
DBC:DB91-01128A

2. Consumption of pulse input CH1~CH8 will be displayed in order.

CH1:00000.0kWh
CH2:00000.0kWh

3. Current time will be displayed after the consumption of CH8.
It displays CH1~CH8 and current time repeatedly.
 - You can make the display stop moving with using [Set] button for easy view.
 - You can find which channel you want to see with using the [▲],[▼] buttons.



PIM Menu Description

Monitoring Menu

Address

1. Access to main menu by pressing the [Menu] button from the normal display. Then select '1.Monitoring' by pressing the [Set] button.

Main Menu
1. Monitoring

2. To check the Address, press the [Set] button when '1.1 Address' appears.

1. Monitoring
1.1 Address

1.1 Address
58 30 FF



NOTE

"58 30 FF" is an example. It is subject to change according to the setting.

- Make sure to reset the PIM after changing the rotary switch.
- First byte represents PIM (58), second byte represents assigned address (between 30~3F) and last byte is fixed to FF.

3. After checking, press the [Menu] button to move to upper menu or cancel the setting.
 - All menus will return to the normal display if there is no input for 1 minute.

Option Switch(For monitoring only)

1. Access to main menu by pressing the [Menu] button from the normal display. Then select '1.Monitoring' by pressing the [Set] button.

1. Monitoring
1.2 Option S/W

2. Move to '1.2 Option S/W' menu by pressing the [▲], [▼] buttons, then select it by pressing the [Set] button.

1.2 Option S/W
1X



NOTE

Example display : 1X

- Option switch 1 : On
- Option switch 2 : Off



3. After the checking, press the [Menu] button to move to upper menu or cancel the setting.
 - All menus will return to the normal display if there is no input for 1 minute.





Micom Version

1. Access to main menu by pressing the [Menu] button from the normal display. Then select '1.Monitoring' by pressing the [Set] button.

Main Menu
1.Monitoring

2. To check the Micom Version, press the [Set] button when '1.3 Micom Ver.' appears.

1.Monitoring
1.3 Micom Ver.

1.3 Micom Ver.
130123



• "130123" is an example.

3. After checking, press the [Menu] button to move to upper menu or cancel the setting.
 - All menus will return to the normal display if there is no input for 1 minute.

DB Code

1. Access to main menu by pressing the [Menu] button from the normal display. Then select '1.Monitoring' by pressing the [Set] button.

Main Menu
1.Monitoring

2. To check the DB Code, press the [Set] button when '1.4 DB Code' appears.

1.Monitoring
1.4 DB Code

1.4 DB Code
DB91-01128A



• "DB91-01128A" is an example.

3. After checking, press the [Menu] button to move to upper menu or cancel the setting.
 - All menus will return to the normal display if there is no input for 1 minute.



PIM Menu Description

Configuration menu

Setting the Password

- ▶ You should enter the password to use Configuration menu.

Password Set

1. Access to main menu by pressing the [Menu] button from the normal display. Then select '2.Configuration' by pressing the [▲], [▼] buttons, and press the [Set] button.

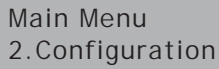

Main Menu
2. Configuration

2. Enter the password using the [▲], [▼] buttons and press the [Set] button.
 - The default password is '0000'.

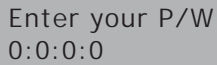

Enter your P/W
0:0:0:0

3. Select '2.1 Password' by pressing the [Set] button.

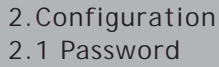

2. Configuration
2.1 Password

4. Select 'Password Set' by pressing the [Set] button to set the new password.



2.1 Password
Password Set

5. Set the new password using the [▲], [▼] buttons and press the [Set] button.



Set your P/W
■: ■: ■: ■

6. Press the [Set] button to save the setting.



Save Settings
0:0:0:0

7. After the setting, press the [Menu] button to move to upper menu or cancel the setting.
 - All menus will return to the normal display if there is no input for 1 minute.





Password Reset

1. Access to main menu by pressing the [Menu] button from the normal display. Then select '2.Configuration' by pressing the [▲], [▼] buttons, and press [Set] button.

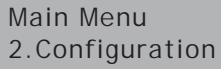

Main Menu
2. Configuration

2. Enter the password using the [▲], [▼] buttons and press the [Set] button.
 - The default password is '0000'.

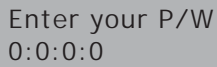

Enter your P/W
0:0:0:0

3. Select '2.1 Password' by pressing the [Set] button.

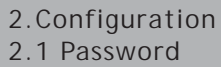

2. Configuration
2.1 Password

4. Select 'Password Reset' by pressing the [Set] button to reset the password.

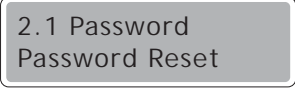

2.1 Password
Password Reset

5. Press the [Set] button to reset the password. To cancel resetting, press the [Menu] button.
 - If you press the [Set] button, the password will reset to '0000'.

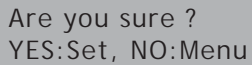

Are you sure ?
YES:Set, NO:Menu

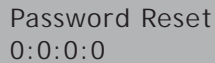

Password Reset
0:0:0:0

6. After the setting, press the [Menu] button to move to upper menu or cancel the setting.
 - All menus will return to the normal display if there is no input for 1 minute.



PIM Menu Description

Setting the Meter Type

▶ You can set the meter type.

1. Access to main menu by pressing the [Menu] button from the normal display. Then select '2.Configuration' by pressing the [▲], [▼] buttons, and press the [Set] button.

Main Menu
2. Configuration

2. Enter the password using the [▲], [▼] buttons and press the [Set] button.
 - The default password is '0000'.

Enter your P/W
0:0:0:0

3. Select '2.2 Meter Type' by pressing the [▲], [▼] buttons and then press the [Set] button.

2. Configuratuion
2.2 Meter Type

4. Move to the channel you want to set by pressing the [▲], [▼] buttons, and then press the [Set] button.
 - You can select each channel or all channel altogether.

2.2 Meter Type
CH1:Power Meter

5. Modify the meter type by pressing the [▲], [▼] buttons.
 - Dafult value: Power Meter
 - Type: Power Meter, Gas meter, Water Meter
 - To apply same type of the meter to all channels at once, select 'ALL Channel' in step 4.

Set CH1 Meter
CH1:Power Meter

6. Press the [Set] button to save the setting.
7. After the setting, press the [Menu] button to move to upper menu or cancel the setting.
 - All menus will return to the normal display if there is no input for 1 minute.





Setting the Pulse Rate

► You can set the pulse constant (Wh/Pulse or m³/Pulse or L/Pulse) value of the meter connected to each channel.

1. Access to main menu by pressing the [Menu] button from the normal display. Then select '2.Configuration' by pressing the [▲], [▼] buttons, and press the [Set] button.

Main Menu
2. Configuration

2. Enter the password using the [▲], [▼] buttons and press the [Set] button.
 - The default password is '0000'.

Enter your P/W
0:0:0:0

3. Select '2.3 Pulse Rate' by pressing the [▲], [▼] buttons and then press the [Set] button.

2. Configuratuion
2.3 Pulse Rate

4. Move to the channel you want to set by pressing the [▲], [▼] buttons, and then press the [Set] button.
 - You can select each channel or all channel altogether.

2.3 Pulse Rate
CH1:00001Wh/P

5. Modify the digit by pressing the [▲], [▼] buttons.
You can move to the next digit by pressing the [Set] button.

Default

- Power : 1Wh/P
- Gas : 0.001m³/P
- Water : 1L/P

Constant range

- Power : 1Wh/P ~ 10,000Wh/P
- Gas : 0.001m³/P ~ 10m³/P
- Water : 1L/P ~ 10,000L/P

Set CH1 Value
CH1:00001Wh/P

6. Press the [Set] button to save the setting.
7. After the setting, press the [Menu] button to move to upper menu or cancel the setting.
 - All menus will return to the normal display if there is no input for 1 minute.



PIM Menu Description

Setting the Date and Time

Date setting

1. Access to main menu by pressing [Menu] button from the normal display. Then select '2.Configuration' by pressing the [▲], [▼] buttons, and press [Set] button.

Main Menu
2. Configuration

2. Enter the password using the [▲], [▼] buttons and press the [Set] button.
 - The default password is '0000'.

Enter your P/W
0:0:0:0

3. Select '2.4 Date&Time' by pressing the [▲], [▼] buttons and then press the [Set] button.

2.4 Date&Time
Current Date

4. Select 'Current Date' to set the date by pressing the [Set] button.
5. Previously set date will be displayed. Press the [Set] button to set the current date. (Y/M/D)
 - Press the [Menu] button to return to the upper menu.

Current Date
2010.01.05

6. Modify the date in order of year, month and day by pressing the [▲], [▼] buttons. You can move to the next item by pressing the [Set] button.

Set Current Date
2010.01.05

7. Press the [Set] button to save the setting.
 - Press the [Menu] button to return to the upper menu.

Save Settings
2010.01.05

8. After the setting, press the [Menu] button to move to upper menu or cancel the setting.
 - All menus will return to the normal display if there is no input for 1 minute.





Time setting

1. Access to main menu by pressing [Menu] button from the normal display. Then select '2.Configuration' by pressing the [▲], [▼] buttons, and press [Set] button.

Main Menu
2. Configuration

2. Enter the password using the [▲], [▼] buttons and press the [Set] button.
 - The default password is '0000'.

Enter your P/W
0:0:0:0

3. Select '2.4 Date&Time' by pressing the [▲], [▼] buttons and then press the [Set] button.

2.4 Date&Time
Current Time

4. Select 'Current Time' to set the time by pressing the [▲], [▼] buttons and then press the [Set] button.

5. Previously set time will be displayed. Press the [Set] button to set the current time. (H/M/S)
 - Press the [Menu] button to return to the upper menu.

Current Time
11:25:14 (PM)

6. Modify the date in order of hour, minute and second by pressing the [▲], [▼] buttons. You can move to the next item by pressing the [Set] button.

Set Current Time
11:25:09 (PM)

7. Press the [Set] button to save the setting.
 - Press the [Menu] button to return to the upper menu.

Save Settings
11:25:17 (PM)

8. After the setting, press the [Menu] button to move to upper menu or cancel the setting.
 - All menus will return to the normal display if there is no input for 1 minute.



PIM Menu Description

Setting the Enable/Disable Status of Channel

▶ Enable/Disable the 8 pulse input channels.

1. Access to main menu by pressing the [Menu] button from the normal display. Then select '2.Configuration' by pressing [▲], [▼] buttons, and press the [Set] button.

Main Menu
2. Configuration

2. Enter the password the [▲], [▼] buttons and then press the [Set] button.
 - The default password is '0000'.

Enter your P/W
0:0:0:0

3. Select '2.5 Channel Use' by pressing the [▲], [▼] buttons and then press the [Set] button.

2. Configuration
2.5 Channel Use

4. Move to the channel you want to set by pressing the [▲], [▼] buttons, and then press the [Set] button.
 - You can select each channel or all channel altogether.

2.5 Channel Use
Channel1:En

5. **Enable** : Press the [Set] button when 'Enable Channel#' appears.
Disable : Press the [▲], [▼] buttons and then press [Set] button when 'Disable Channel#' appears.
 - To enable/disable all channels, select 'ALL' in step 4.
 - Disabled channel will not be displayed on the normal display.

Enable Channel1
YES:Set, NO:Menu

Disable Channel1
YES:Set, NO:Menu

6. After the setting, press the [Menu] button to move to upper menu or cancel the setting.
 - All menus will return to the normal display if there is no input for 1 minute.





Setting the Initial Value

► You can set the initial value for each channel.

1. Access to main menu by pressing the [Menu] button from the normal display. Then select '2.Configuration' by pressing the [▲], [▼] buttons, and press the [Set] button.

Main Menu
2. Configuration

Enter your P/W
0:0:0:0

2. Enter the password the [▲], [▼] buttons and then press the [Set] button.
 - The default password is '0000'.

3. Select '2.6 Value Set' by pressing the [▲], [▼] buttons and then press the [Set] button.

2. Configuration
2.6 Value Set

2.6 Value Set
CH1:00000.0kWh

4. Move to the channel you want to set by pressing the [▲], [▼] buttons, and then press the [Set] button.
 - You can select each channel or all channel altogether.

5. Modify the digit by pressing the [▲], [▼] buttons. You can move to next digit by pressing the [Set] button.
 - You can modify the initial value of the channel you wish to change.
 - If you modify the setting, saved value will be reset and the device will re-calculate the value according to the modified value.
 - To set the initial value for all channels, select 'ALL Channel' in step 4.

Set Ch1 kWh
CH1:00000.0kWh

Save Settings
CH1:00000.0kWh

6. Press the [Set] button to save the setting.
7. After the setting, press the [Menu] button to move to upper menu or cancel the setting.
 - All menus will return to the normal display if there is no input for 1 minute.



PIM Menu Description

Initializing the usage value for each channel

1. Access to main menu by pressing the [Menu] button from the normal display. Then select '2.Configuration' by pressing the [▲], [▼] buttons, and press the [Set] button.

Main Menu
2. Configuration

2. Enter the password the [▲], [▼] buttons and then press the [Set] button.
 - The default password is '0000'.

Enter your P/W
0:0:0:0

3. Select '2.7 Value Clear' by pressing the [▲], [▼] buttons and then press the [Set] button.

2. Configuration
2.7 Value Clear

4. Move to the channel you want to set by pressing the [▲], [▼] buttons, and then press the [Set] button.
 - You can select each channel or all channel altogether.

2.7 Value Clear
CH1: 00000.0kWh

5. Press the [Set] button to initialize the selected channel when the caution message appears.
 - Clear : Initializes the consumption calculated so far.
 - To cancel the initialization, press the [Menu] button.
 - To initialize all channels, you can select 'ALL Channel' in step 4.

Are you Sure?
YES:Set, No:Menu

Save Settings
Clear CH1 Value

6. Press the [Set] button to save the setting.
7. After the setting, press the [Menu] button to move to upper menu or cancel the setting.
 - All menus will return to the normal display if there is no input for 1 minute.





Check Menu

Pulse Input Status Check

▶ You can check the status of pulse which is input to each channel.

1. Access to main menu by pressing the [Menu] button from the normal display. Then select '3. Check' by pressing the [▲], [▼] buttons, and press [Set] button.

Main Menu
3. Check

2. Select '3.1 Pulse Input' by pressing the [Set] button.

3. Check
3.1 Pulse Input

3. Move to the channel you want to check by pressing the [▲], [▼] buttons, and then press the [Set] button.
 - You can select each channel or all channel altogether.

Result : You can check pulse input status of the selected channel.

- If there is no pulse width limit and high level signal is input, the result will be calculated.

3.1 Pulse Input
CH1 Check OK

CH1 Check Start
Checking...

4. The result regarding the pulse input of the channel will be displayed.(OK/NG)
 - NG will be displayed when there is no input within 10 seconds after selecting the channel.
 - If the pulse input is normal : Displayed in number
 - If there is no pulse input : Displayed 'X'
 - CH1, 3, 4, 6, 8 : No pulse input
 - CH2, 5, 7 : OK
 - PIM does not calculate the consumption during the inspection. Calculation will start after the inspection and returning to the upper menu.
 - To check the status of all channels, select 'All Check OK' in step 4.

CH1 Check End
NG

All Check End
X2XX5X7X

5. After the setting, press the [Menu] button to move to upper menu or cancel the setting.
 - All menus will return to the normal display if there is no input for 1 minute.



PIM Menu Description

Check the RS485 Circuit of PIM itself for Test or Service

- ▶ You can check if the RS485 circuit is normal when you have doubt the main board.
- ▶ Before checking, connect COM1 and COM2 terminal with wire as you see the right figure.

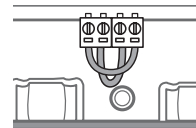

1. Access to main menu by pressing the [Menu] button from the normal display.
Then select '3. Check' by pressing the [▲], [▼] buttons, and press the [Set] button.

Main Menu
3. Check

2. Select '3.2 COM'Check' by pressing the [▲], [▼] buttons and then press the [Set] button.
 - Inspect the packet transmission/reception status with DMS.

3. Check
3.2 COM' Check

COM' Check Start
Checking...

3. Communication inspection result will be displayed. (OK/NG)

COM' Check End
OK

4. After the inspection, press the [Menu] button to move to upper menu or cancel the setting.
 - All menus will return to the normal display if there is no input for 1 minute.



Checking the Pulse Width Setting Error

▶ It checks if the pulse width setting for each channel and the pulse width of actually connected Meter are same or not.

1. Access to main menu by pressing the [Menu] button from the normal display. Then select '3. Check' by pressing the [▲], [▼] buttons, and press the [Set] button.

Main Menu
3. Check

2. Select '3.3 Pulse Width' by pressing the [▲], [▼] buttons and then press the [Set] button.

3. Check
3.3 Pulse Width

3. Move to the channel you want to check by pressing the [▲], [▼] buttons, and then press the [Set] button.
 - It will check the status of pulse input. Then it will show the result of pulse input.

3.3 Pulse Width
CH1 Check OK

CH1 Check Start
Checking...

4. The result of pulse input for the selected channel will be displayed. (OK/NG, setting, measurement)

OK : When the pulse is valid (pulse is valid when high pulse between 20 ~ 1000msec), OK (M:####msec) will be displayed.
represent the duration of the high pulse.

NG : When the pulse is invalid (pulse is valid when high pulse is between 20 ~ 1000msec), or when there's no pulse input for 10 seconds, NG (M: 0000msec) will be displayed.

- PIM does not calculate the consumption during the checking process. Calculation will start after the check and returning to the upper menu.

CH1 Check End
NG (M: 0000msec)

5. After the checking, press the [Menu] button to move to upper menu or cancel the setting.
 - All menus will return to the normal display if there is no input for 1 minute.



SAMSUNG

