



Air Handling Unit  
Application Kit

MXD-K025AN  
MXD-K050AN  
MXD-K075AN  
MXD-K100AN  
MXD-X000AN

# Air Conditioner

## installation manual

imagine the possibilities

Thank you for purchasing this Samsung product.

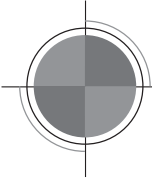

# Contents

---

<b>SAFETY INFORMATION</b> .....	<b>3</b>	<b>FUNCTION SETTING</b> .....	<b>19</b>
		• Setting an indoor unit address and installation option .....	19
<b>EXTERNAL APPEARANCE</b> .....	<b>5</b>	<b>TROUBLESHOOTING</b> .....	<b>28</b>
• External Appearance .....	5	• Initial Check-up .....	28
<b>ACCESSORIES</b> .....	<b>6</b>	• EEPROM Error .....	28
• Accessories .....	6	• Sensor Error .....	29
<b>BEFORE INSTALLATION</b> .....	<b>7</b>	• Fan Error .....	31
• AHU-KIT Structure Diagram .....	7	• How to Inspect Just in Case the Below Condition is Satisfied .....	32
• Recommended AHU Size .....	7	• In-tracking Error .....	33
<b>INSTALLATION</b> .....	<b>8</b>	<b>AFTER INSTALLATION</b> .....	<b>35</b>
• Control-KIT Installation .....	8	• AHU-KIT Installation Check .....	35
• Control-KIT Function .....	9	• Test Operation .....	36
• Control-KIT Circuit Diagram .....	10		
• External Controller Diagram .....	11		
• Simple BMS .....	11		
• Connecting the Power Terminal .....	13		
• Control-KIT Connections .....	14		
• Brazing the Pipe .....	14		
• EEV-KIT Installation .....	15		
• EVA IN/OUT Sensor Installation .....	16		

# SAFETY INFORMATION

The following safety precautions must be taken when installing the unit.

**Be aware that AHU-KIT has to be combined with DVM S Series outdoor unit only.**

## Use R410A refrigerant.

- When using R410A, moisture or foreign substances may affect the capacity and reliability of the product. Safety precautions must be taken when installing the refrigerant pipe.
- R410A is a quasi-azeotrope of two refrigerants. Make sure to charge liquid one when adding refrigerant. (If you charge gaseous refrigerant, it may affect the capacity and reliability of the product as a result of change in formation of the refrigerant.)

## WARNING

Risk of death or serious personal injury.

## CAUTION

Potential risk of personal injury or material damage.

## CAUTION

**Turn off the power before installation, service, and cleaning.**

**The installation must be done by the manufacturer or its service agent or a similar qualified person in order to avoid a hazard.**

- Installation by an unqualified person may cause a water leakage, electric shock or fire .

**Install the outdoor unit correctly according to the installation manual.**

**Manufacturer is not responsible for accidents due to incorrect installation by unqualified person.**

- An incorrect installation may cause a water leakage, electric shock or fire and so on.

**Use only rated parts and tools.**

**When adding the refrigerant, use the R410A refrigerant only.**

- If you don't use the rated parts and tools, it can cause trouble with the product and bring about injury.

- If any gas or impurities except R410A refrigerant come into the refrigerant pipe, serious problem may occur and it may cause injury.

**Use the pipe or flare part for R410A refrigerant only.**

**When there were leakage during installation, you must ventilate the area.**

- Toxic gas may generate when refrigerant gas contacts with fire.

**If the power cable or cord is damaged, the manufacturer, a qualified service technician must replace it to avoid a potential risk.**

**The electric work must be done by service agent or similarly qualified persons according to national wiring regulations and use only rated cable.**

- If the capacity of the power cable is insufficient or electric work is not properly completed, electric shock or fire may occur.

**Arrange the cables between the AHU-KIT and outdoor unit after connecting. Attach the cover securely so that the electrical component box cover does not get loosen.**

**Install designated ELB for AHU when installing the power cable.**

- If you do not install designated ELB for AHU, electric shock or fire may occur.

- If the cover is attached incompletely, it can cause trouble with a heat generation, electric shock or fire of the terminal board.

## CAUTION

**Install the cables with supplied cables firmly. Fix them securely so that external force is not exerted to the terminal board.**

- If the connection or fixing is incomplete, it can cause trouble with a heat generation, electric shock or fire.

**Use the copper wire for the power cable and use only rated cables and parts.**

**Make sure that the power for AHU-KIT is under maximum, and over minimum voltage allowed.**

- It may cause electrical component malfunction which can damage the product.

**Make sure electrical circuit is correctly connected.**

- Overheating may cause fire.

**Make sure there is no leakage after installation.**

- Toxic gas may generate when refrigerant gas contacts with fire.

## WARNING

**Make sure of a earthing.**

- Do not connect the earth wire to the gas pipe, water pipe, lighting rod or telephone wire.
- If earthing is incomplete, electric shock or fire may occur.

**Follow the instructions in this manual to make sure that the condensed water dripping from the drain hose runs out properly and insulate the drain pipe so that dew condensate does not generate.**

- Household goods may get wet if the drain pipe is not properly installed.

**Install the power cable and communication cable of the AHU-KIT at least 1m away from electric appliances.**

- Noise may heard depending on the electric wave though the cables are installed away from electric appliances.
- Keep the space in front of AHU-KIT for maintenance.

**Do not install the AHU-KIT in following places.**

- The place where there is mineral oil or arsenic acid.
  - There is a chance that parts may get damaged due to burned resin.
- The place where corrosive gas such as sulfurous acid gas generates from the vent pipe or air outlet.
  - The copper pipe or connection pipe may corrode and refrigerant may leak.
- The place where there is a machine that generates electromagnetic waves.
  - The air conditioner may not operate normally due to control system.
- The place where there is a danger of existing combustible gas, thinner or gasoline is handled.
  - The place where carbon fiber or flammable dust is.
- The place where like spa and shore.
- The place with direct contact of sunlight, rain, outdoor humidity, dust and temperature.

※ The manufacturer is not responsible for the damage occurred by not keeping standard of the installation.

# EXTERNAL APPEARANCE

## External Appearance

### EEV-KIT

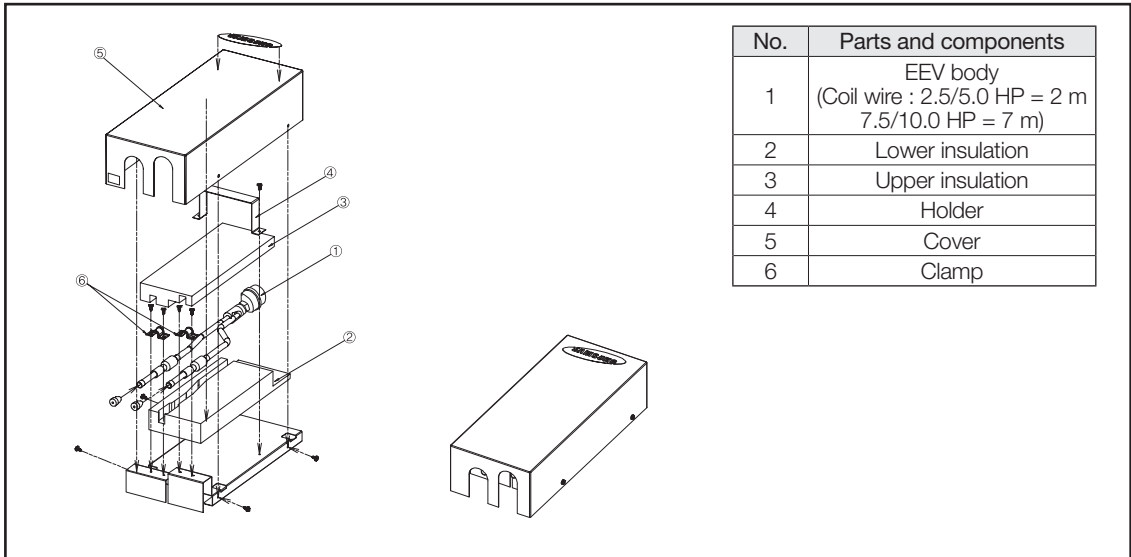





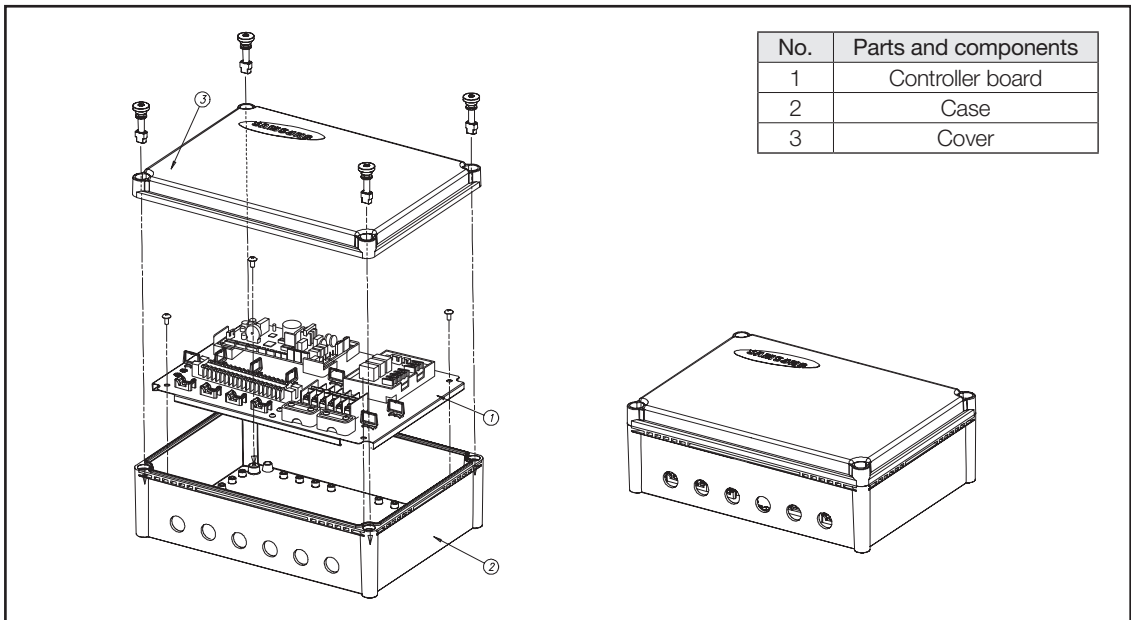

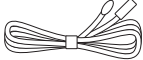
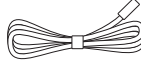
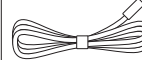

\* EEV -Kit is not included in the Model "MXD-X000AN".

### Control-KIT

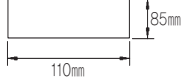
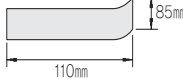
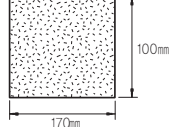

# ACCESSORIES

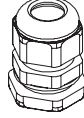
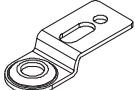
## Accessories

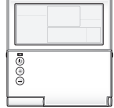
ITEM	Room/EVA IN sensor (10 m)	EVA OUT sensor (10 m)	Disch. sensor (10 m)	EVA IN sensor holder (OD Ø 6.8 mm)	EVA OUT sensor holder (OD Ø 7.8 mm)	Sensor clip
QUANTITY	1	1	1	1	1	2
IMAGE						
ITEM	Aluminum tape		Rubber tape		Insulator	
QUANTITY	4		2		2	
IMAGE						
ITEM	Cable-tie	Cable-nut PG16	Bracket Base	Installation Manual	Screw plug PG16	Wired Remote Controller (optional)
QUANTITY	8	6	4	1	2	1
IMAGE						

\* The Room/EVA IN/EVA OUT/Disch. sensors & Cable-nuts are not included in the Model "MXD-X000AN".

# BEFORE INSTALLATION

## AHU-KIT Structure Diagram

※ This Diagram is the example of VRF System with AHU Kit (MXD-K025/050/075/100AN).

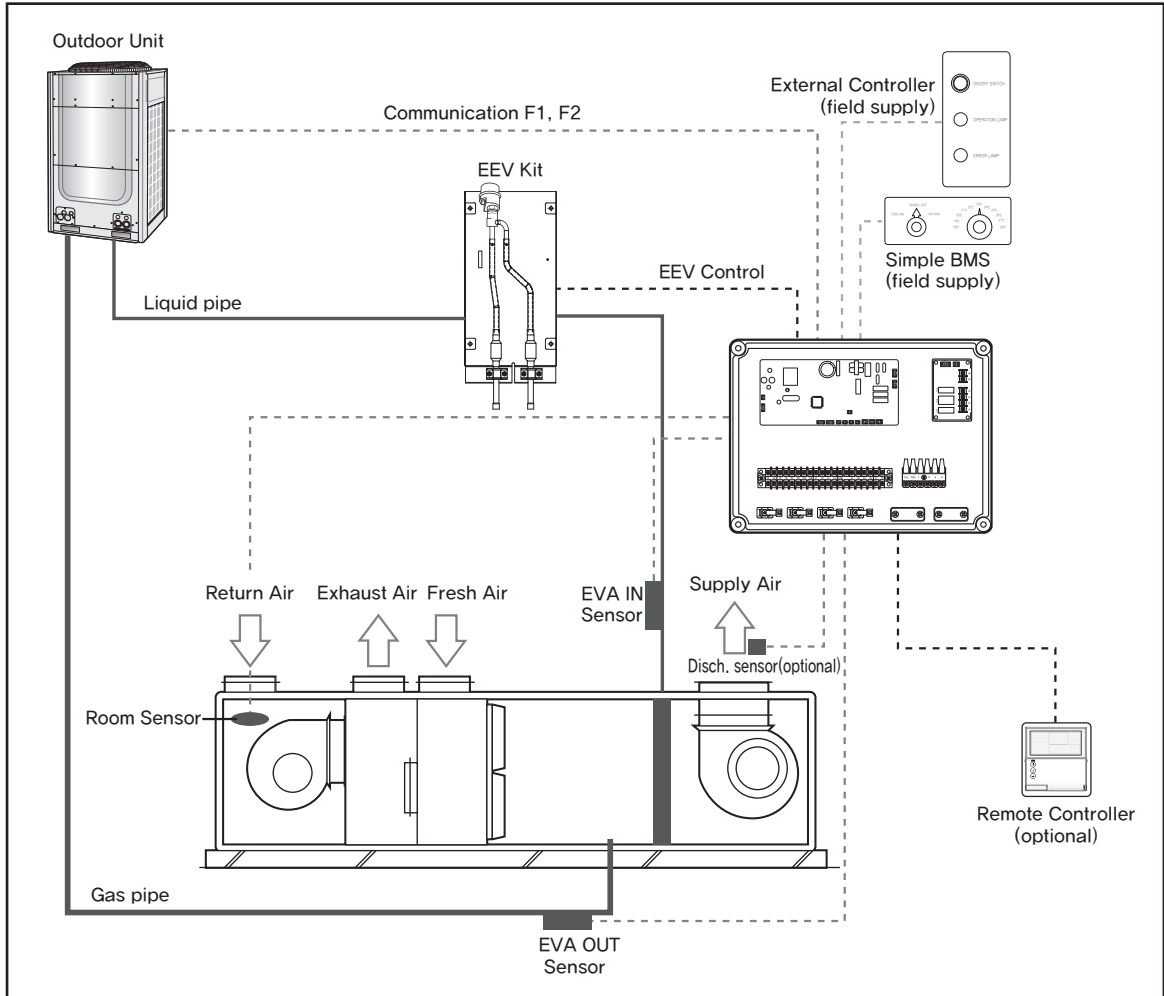

- When the controllers (External Controller, simple BMS, Remote Controller) are installed simultaneously, AHU-KIT doesn't have the priority of control and operates according to the final signal. (SIMPLE BMS may indicate the different condition of AHU, if AHU was controlled by other controller finally.)

## Recommended AHU Size

Model	AHU Capacity (kW)		Heat Exchanger Volume (cm <sup>3</sup> )	
	Min	Max	Min	Max
MXD-K025AN	6.3	8.8	1200	2000
MXD-K050AN	12.6	17.5	2400	4000
MXD-K075AN	18.9	24.9	4100	6000
MXD-K100AN	25.2	35.0	6100	8000

※ Evaporating Temperature : 7°C, Superheat : 1°C, Air temperature : 27°CDB/19°CWB

# INSTALLATION

## Control-KIT Installation



- Make sure that Control-KIT should be installed within short distance from the EEV-KIT.
  - Supplied sensor in the Accessory box is 10 m.
  - 2.5/5.0HP EEV wire is 2 m
  - 7.5/10.0HP EEV wire is 7 m
- Close the box with the cover and cable-nut securely so that Control-KIT is fireproofed.
- Avoid installing the unit in a location exposed to direct sunlight or rain.

- 1) Drill 4 holes on the correct position of the wall and fix the Control-KIT securely. (refer to the dimension of figure below.)
- 2) Open the box and connect the cables according to the diagram. (Wires should be pulled through the Cable-nut, before connecting to the terminal. Refer to the figure below.)
- 3) Fix the cable firmly with Cable-tie after connecting.
- 4) Close the box.

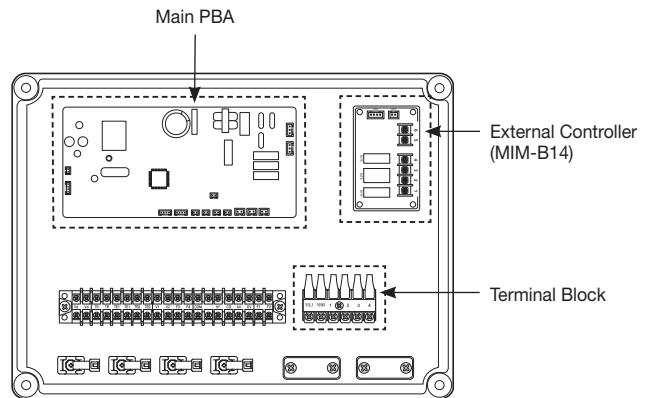
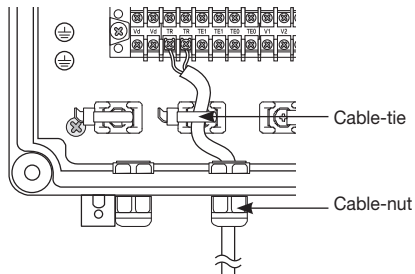
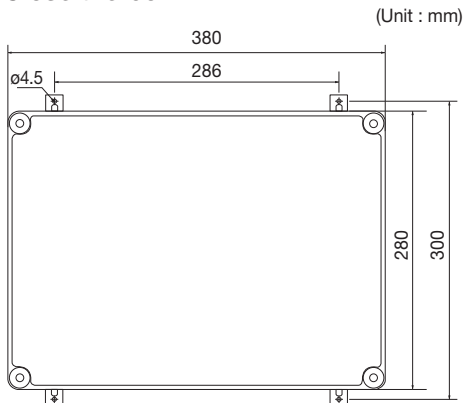



## Control-KIT Function

- Control-KIT uses EEV to control the amount of refrigerant flow and controls the system through outdoor unit and wired remote controller.
- Control-KIT outputs the contact signal for AHU fan operation.  
Terminal block 1, 2 (Refer to page 10) outputs the AHU fan ON contact signal 220 - 240 V(208 - 230 V for US) for AHU when operating in Cool/Heat/Fan mode. This contact signal output can not be used as power supply for the motor.
- Terminal block 3, 4 (Refer to page 10) is for AHU-KIT control to receive the fan operation status. This input signal should be simple OPEN/SHORT signal without any extra voltage.
  - Normal fan operation : Terminal block 3, 4 is in SHORT.
  - Fan is not in operation : Terminal block 3, 4 is in OPEN.
  - To use fan feedback to protect your system, set the 05 series installation option SEG21(Refer to page 26) to "1".
- Connect 220 - 240 V, 50 / 60 Hz (208 - 230 V, 60 Hz for US) to terminal block 1(L)/2(N).
- You should connect outdoor unit communication cable to communication line (F1, F2)(Refer to page 10).
- F3, F4(Refer to page 10) is communication line for wired remote controller(12 V).

## Control-KIT Circuit Diagram

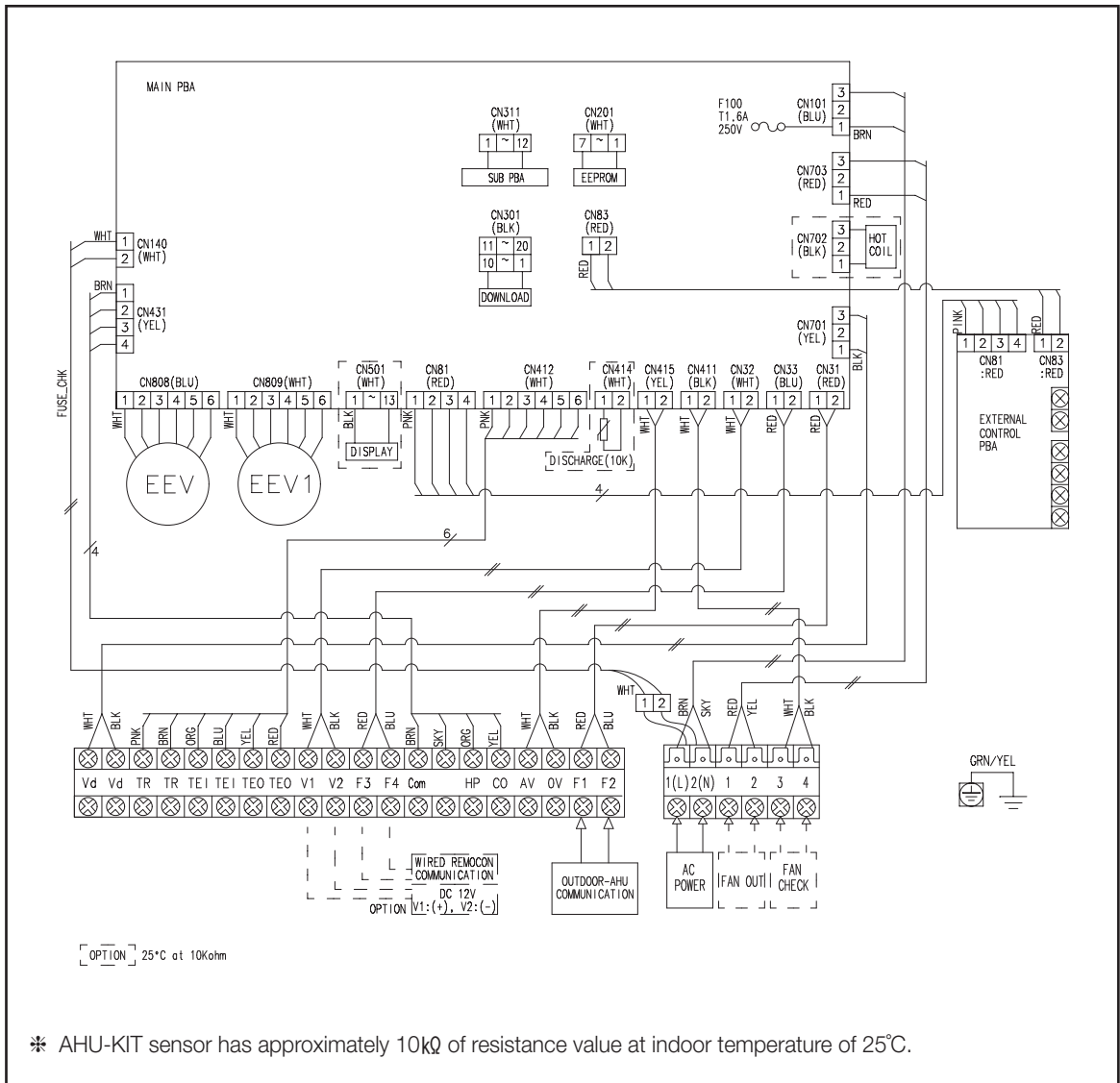

## External Controller Diagram (MIM-B14)

### Circuit diagram of external controller's output

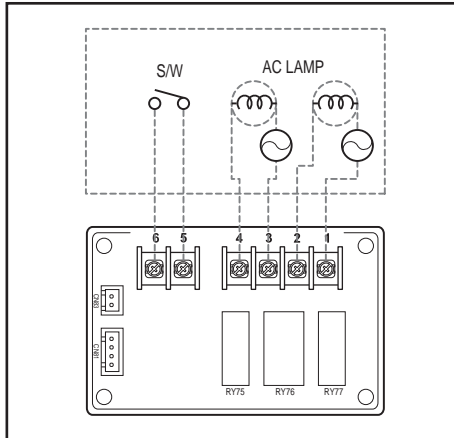

### Operation specification according to AHU-KIT PBA Install option set up

WIRE NO.	Signal	Install option
1, 2	Error check output	-
3, 4	Operation check output	SEG 15
5, 6	ON/OFF input	SEG 14



- In order for AHU-KIT to be controlled by External control, change a digit of indoor unit installation option, set the SEG14 as "1". (ON / OFF control)

## Simple BMS

### Simple BMS setting

- Simple BMS can control Room temperature or Discharge temperature by setting SEG17 of 5 series Installation option.
  - For controlling Room temperature : SEG17 of 5 series Installation option → 0
  - For controlling Discharge temperature : SEG17 of 5 series Installation option → 1
- Discharge temperature can be set by DMS.
- Simple BMS control is not influenced by DMS's restrictions on operation mode, set temperature or remote controller usage.
- If you want to set Room temperature or Discharge temperature by using Simple BMS, setting Buzzer control option as "Disuse buzzer" is recommended.

### Circuit diagram of Simple BMS

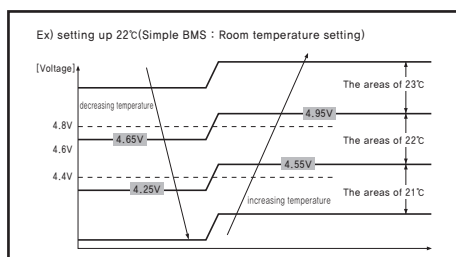
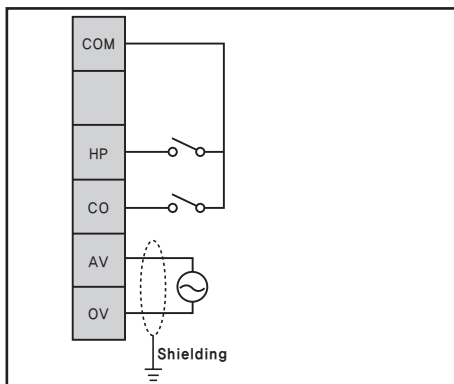

- Hysteresis is applied to the end of voltage range in order to stabilize the analog input.  
The amount of Hysteresis
  - Room temperature setting: 0.15 V
  - Discharge temperature setting: 0.08 V

## Operational Voltage range against Setting temperature

### Room temperature setting

Simple BMS Voltage Range	Set Temperature	
	Heating	Cooling
10.0 V ~ 9.6 V	30 °C	30 °C
9.6 V ~ 9.2 V	30 °C	30 °C
9.2 V ~ 8.8 V	30 °C	30 °C
8.8 V ~ 8.4 V	30 °C	30 °C
8.4 V ~ 8.0 V	30 °C	30 °C
8.0 V ~ 7.6 V	30 °C	30 °C
7.6 V ~ 7.2 V	29 °C	29 °C
7.2 V ~ 6.8 V	28 °C	28 °C
6.8 V ~ 6.4 V	27 °C	27 °C
6.4 V ~ 6.0 V	26 °C	26 °C
6.0 V ~ 5.6 V	25 °C	25 °C
5.6 V ~ 5.2 V	24 °C	24 °C
5.2 V ~ 4.8 V	23 °C	23 °C
4.8 V ~ 4.4 V	22 °C	22 °C
4.4 V ~ 4.0 V	21 °C	21 °C
4.0 V ~ 3.6 V	20 °C	20 °C
3.6 V ~ 3.2 V	19 °C	19 °C
3.2 V ~ 2.8 V	18 °C	18 °C
2.8 V ~ 2.4 V	18 °C	18 °C
2.4 V ~ 2.0 V	18 °C	18 °C
2.0 V ~ 1.6 V	18 °C	18 °C
1.6 V ~ 1.2 V	18 °C	18 °C
1.2 V ~ 0.8 V	18 °C	18 °C
0.8 V ~ 0.4 V	18 °C	18 °C
0.4 V ~ 0.0 V	18 °C	18 °C

### Discharge temperature setting

Simple BMS Voltage Range	Set Temperature	
	Heating	Cooling
10.00 V ~ 9.75 V	43 °C	43 °C
9.75 V ~ 9.50 V	42 °C	42 °C
9.50 V ~ 9.25 V	41 °C	41 °C
9.25 V ~ 9.00 V	40 °C	40 °C
9.00 V ~ 8.75 V	39 °C	39 °C
8.75 V ~ 8.50 V	38 °C	38 °C
8.5 V ~ 8.25 V	37 °C	37 °C
8.25 V ~ 8.00 V	36 °C	36 °C
8.00 V ~ 7.75 V	35 °C	35 °C
7.75 V ~ 7.50 V	34 °C	34 °C
7.50 V ~ 7.25 V	33 °C	33 °C
7.25 V ~ 7.00 V	32 °C	32 °C
7.00 V ~ 6.75 V	31 °C	31 °C
6.75 V ~ 6.50 V	30 °C	30 °C
6.50 V ~ 6.25 V	29 °C	29 °C
6.25 V ~ 6.00 V	28 °C	28 °C
6.00 V ~ 5.75 V	27 °C	27 °C
5.75 V ~ 5.50 V	26 °C	26 °C
5.50 V ~ 5.25 V	25 °C	25 °C
5.25 V ~ 5.00 V	24 °C	24 °C

Simple BMS Voltage Range	Set Temperature	
	Heating	Cooling
5.00 V ~ 4.75 V	23 °C	23 °C
4.75 V ~ 4.50 V	22 °C	22 °C
4.50 V ~ 4.25 V	21 °C	21 °C
4.25 V ~ 4.00 V	20 °C	20 °C
4.00 V ~ 3.75 V	19 °C	19 °C
3.75 V ~ 3.50 V	18 °C	18 °C
3.50 V ~ 3.25 V	17 °C	17 °C
3.25 V ~ 3.00 V	16 °C	16 °C
3.00 V ~ 2.75 V	15 °C	15 °C
2.75 V ~ 2.50 V	14 °C	14 °C
2.50 V ~ 2.25 V	13 °C	13 °C
2.25 V ~ 2.00 V	12 °C	12 °C
2.00 V ~ 1.75 V	11 °C	11 °C
1.75 V ~ 1.50 V	10 °C	10 °C
1.50 V ~ 1.25 V	9 °C	9 °C
1.25 V ~ 1.00 V	8 °C	8 °C
1.00 V ~ 0.75 V	8 °C	8 °C
0.75 V ~ 0.50 V	8 °C	8 °C
0.50 V ~ 0.25 V	8 °C	8 °C
0.25 V ~ 0.00 V	8 °C	8 °C



- Range of Discharge temperature setting
  - Cooling : 8 ~ 25 °C
  - Heating : 18 ~ 43 °C
- If the voltage value is beyond the range of discharge temperature setting, the temperature is controlled by maximum/minimum value which meets the setting range.  
(Ex : The voltage value of cooling discharge temperature 30 °C → the controlled value : 25 °C)

## Setting the temperature

- Keep the power supply of Simple BMS in 10 V ± 0.2 V.
- If the Simple BMS uses variable resistor(VR), make the electric resistance of VR under 1 kΩ.
- Simple BMS which uses variable resistor(VR) need to be connected to the AHU-KIT with 1:1 link.
- Use the Simple BMS which outputs voltage so that one Simple BMS controls several AHU-KIT at the same time.

### Available

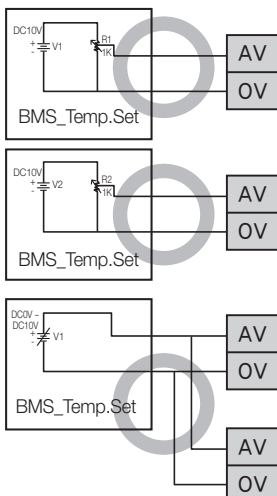

### Not Available

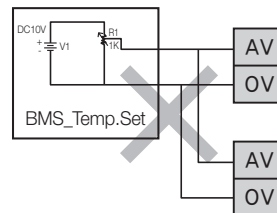

- Make sure that Simple BMS is connected to DC power supply before installing.  
Never connect Simple BMS to AC power supply .

## Connecting the Power Terminal

### Connecting Power/Communication cable

- Turn off the power before connecting the power terminal.
- Maximum cable length and the amount of voltage drop for AHU power/communication cables should be under 10 %.
- Consider power usage of the AHU when installing the ELB.
- Connect F3, F4 on AHU-KIT to the communication line (F3, F4) on wired remote controller. (Refer to page 14)
- Use the appropriate tools for wiring and make sure to connect them tightly within the tightening torque to withstand the external pressure. Arrange the wires so that cover or other parts does not get loose. They may cause overheating, electric shock or fire.
- Connect the power cable to the ELB.

Tightening torque (kgf-cm)	
M4	12.0 ~ 18.0



- Power supply for AHU-KIT should be separate from outdoor unit.
- Do not connect the terminal block power line from one indoor unit to more than one AHU-KIT.
- When peeling the power cable, use the appropriate tools to prevent damaging the wire.
- Communication cable should be installed separately from power cable or other cables.

	Description	Type of cable	Maximum length(m)	Specifications
Vd / Vd	DEFROST Signal	2 x 1.5 mm <sup>2</sup>	-	1 phase 220 - 240 V, 50 / 60 Hz (208 - 230V, 60 Hz for US)
TR/TR	Thermistor Room	2 x 0.75 mm <sup>2</sup>	accessory, 10 m	-
TEI/TEI	Thermistor EVA IN (Liquid pipe)	2 x 0.75 mm <sup>2</sup>	accessory, 10 m	-
TEO/TEO	Thermistor EVA OUT (Gas pipe)	2 x 0.75 mm <sup>2</sup>	accessory, 10 m	-
F3/F4	Communication to Remote Controller	2 x 0.75 mm <sup>2</sup>	-	-
COM/HP/CO	Simple BMS	-	-	-
AV/OV	Simple BMS (Setting Temperature)	2 x 0.75 mm <sup>2</sup>	-	Simple BMS Power
F1/F2	Communication to Outdoor unit	2 x 0.75 mm <sup>2</sup>	-	-
L/N	Power supply	3 x over 1.5 mm <sup>2</sup>	-	1 phase 220 - 240 V, 50 / 60 Hz (208 - 230V, 60 Hz for US)
1/2	Fan on	2 x 0.75 mm <sup>2</sup>	-	1 phase 220 - 240 V, 50 / 60 Hz (208 - 230V, 60 Hz for US)
3/4	Fan check	2 x 0.75 mm <sup>2</sup>	-	Non-voltage contact signal

## Control-KIT Connections

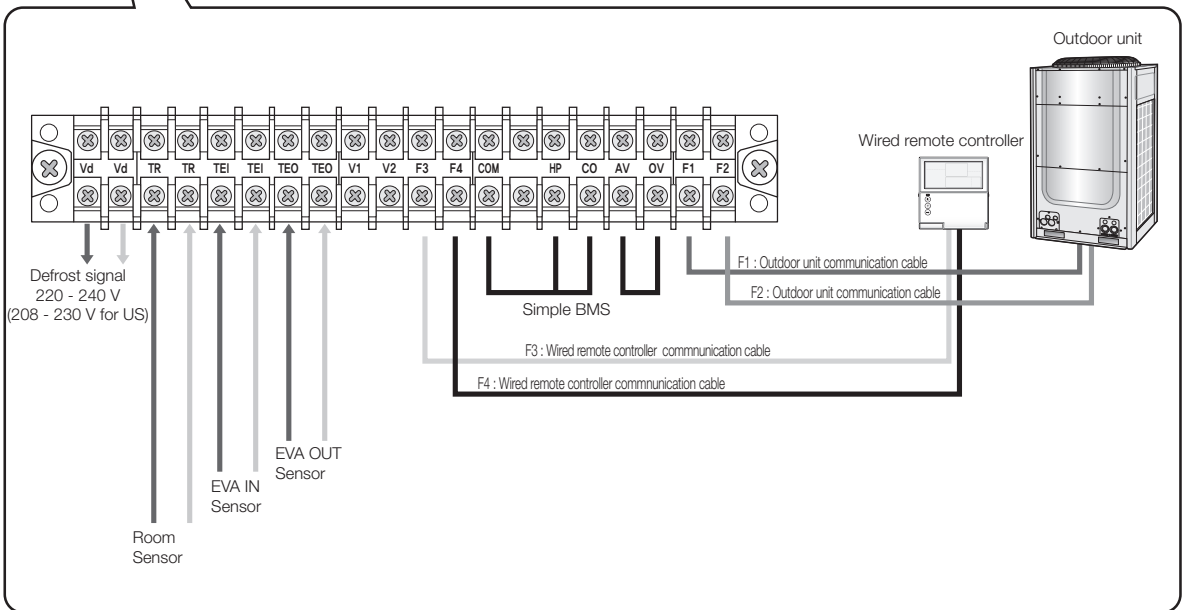
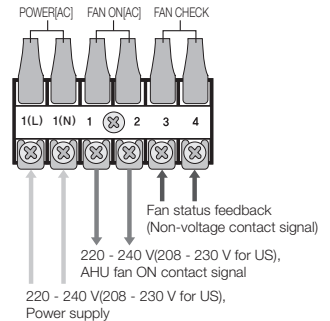
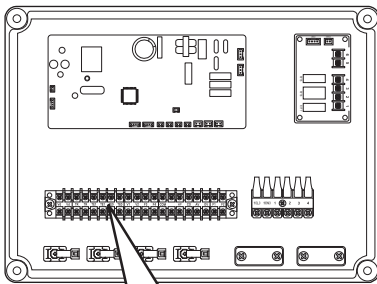

## Brazing the Pipe

- Make sure that there is no moisture inside the pipe.
- Make sure that there are no foreign materials and impurities in the pipe.
- Make sure that there is no leak.
- Be sure to follow the instruction when brazing the pipe.

## The use of Nitrogen gas

- 1) Use Nitrogen gas when brazing the pipes as shown in the picture.
- 2) If you do not use Nitrogen gas when brazing the pipes, oxide may form inside the pipe. It can cause the damage of the compressor, valves.
- 3) Adjust the flow rate of the Nitrogen gas with a pressure regulator to maintain 0.05m<sup>3</sup>/h or less.

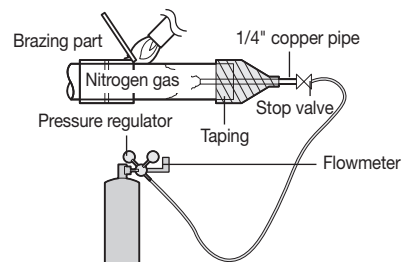

## EEV-KIT Installation



- Make sure that EEV-KIT should be installed within 5m from the heat exchanger. (EEV -Kit is not included in the Model "MXD-X000AN")

- 1) Open the EEV-KIT cover by unscrewing 4 screws on the side of the box.
- 2) Drill 4 holes on the correct position of the wall and fix the EEV-KIT securely. (Refer to the dimension of figure below.)
- 3) Remove the holder by unscrewing 1 screw at the plate.
- 4) Remove upper and lower insulations before brazing. (Clamp doesn't need to be loosened.)
- 5) Braze the pipe as indicated in figure below. (Ensure that IN/OUT pipes are correctly connected.)



- Make sure that filter and valve body should be kept under 120 °C with wet cloth.

- 6) After brazing, when the pipe become cool enough, put the insulations back into the place.
- 7) Attach the upper insulation to the lower insulation with peeling protective layer of upper insulation.
- 8) Fatsen the holder with 1 screw and close the EEV-KIT cover with 4 screws.



- Make sure that pipes are fully insulated. If there is any uninsulated part, it may cause condensation dripping.
- EEV-KIT should be installed in the vertical direction within the range of  $\pm 15^\circ$ . If it is tilted over than  $15^\circ$ , it can badly affect normal operation of EEV.

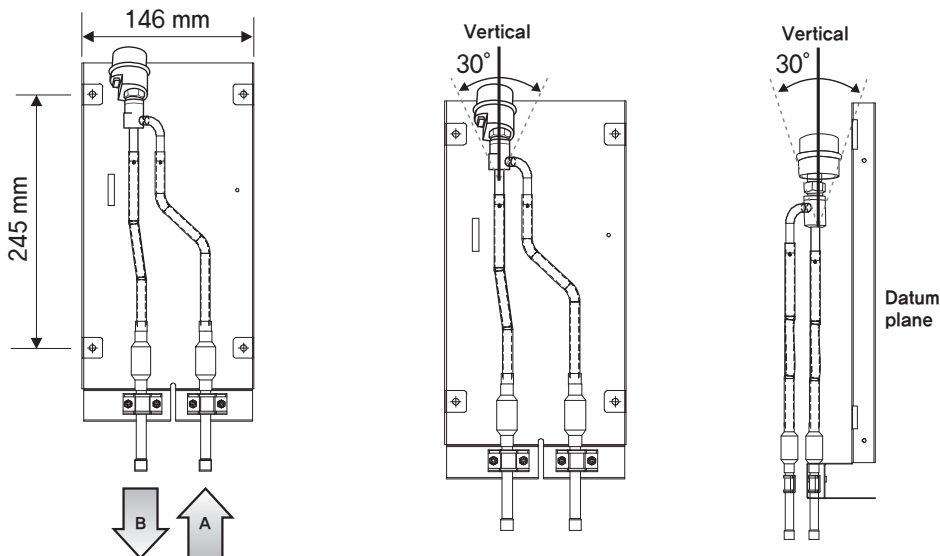

(Refrigerant flow under cooling mode)

A : High pressure pipe from outdoor unit (IN) Diameter :  $\varnothing 9.52$  mm

B : High pressure pipe to AHU heat exchanger (OUT) Diameter :  $\varnothing 9.52$  mm

## Sensor Installation

※ These sensors are not included in the Model "MXD-X000AN".



• Please check sensor usage in label.

ex.

EVA OUT	<input type="checkbox"/>
DISCHARGE	<input checked="" type="checkbox"/>

- 1) EVA IN sensor should be attached after the distributor, on the coldest part of the heat exchanger pipe.
- 2) EVA OUT sensor should be installed approximately 200 mm behind the header of AHU heat exchanger.
- 3) EVA IN/OUT sensor should be insulated for optimized system performance.
- 4) Room temperature sensor should be installed where room air enters.

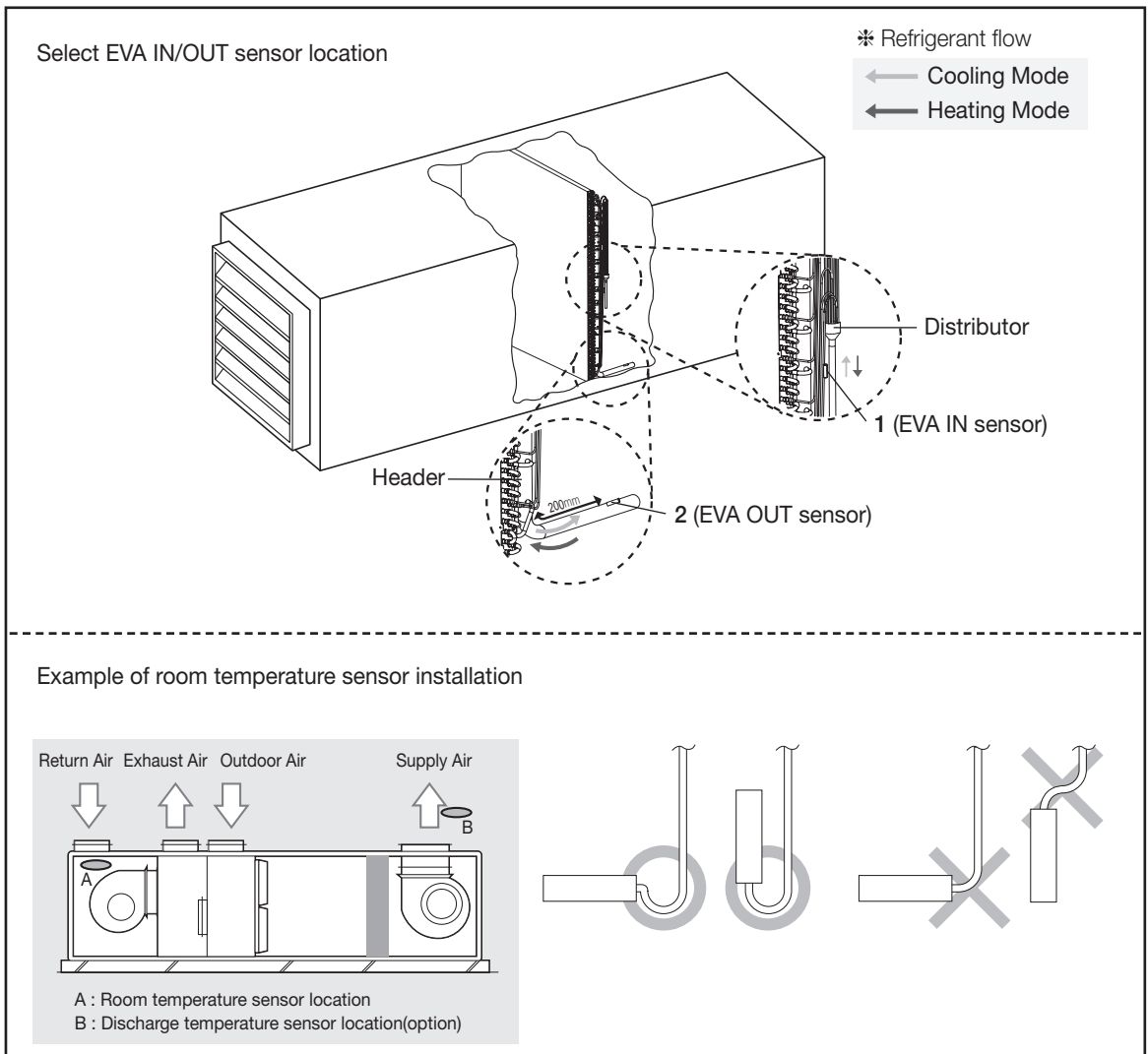

- Braze the sensor holder at location suggested above and fix the sensor with sensor clip.
- EVA IN/OUT sensor should be installed where temperature of heat exchanger can be measured accurately.



## ■ Sensor installation example 1

### 1) Check the sensor and the sensor holder.



Type	Sensor OD(mm)	Sensor holder ID (mm)
EVA IN sensor	Ø 6	Ø 6.8
EVA OUT sensor	Ø 7	Ø 7.8

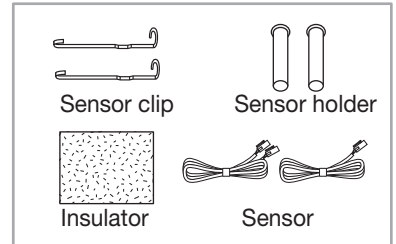

### 2) Braze the sensor holder on the selected location of the pipe.



#### Sensor attachment method.

- Choose the location where temperature can be measured correctly. (Refer to page 16)
- Try to attach closely to the contact surface before brazing.
- Distinguish EVA IN/OUT sensor and attach it. (EVA IN/OUT sensor size is different.)

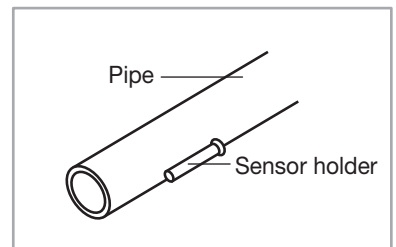

### 3) Insert sensor and the sensor clip in the sensor holder.

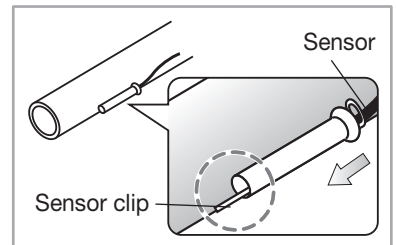

### 4) Bend end of the sensor clip to fix the sensor.

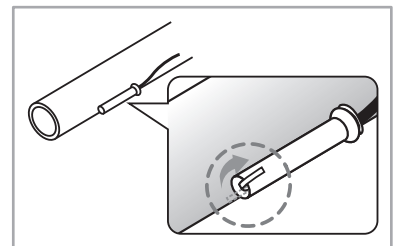

### 5) Attach the insulator around the sensor.

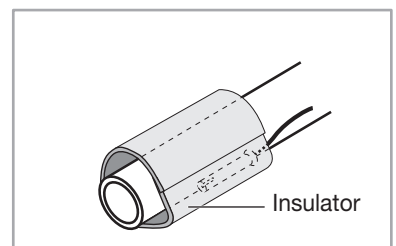

## Sensor installation example 2

### 1) Check the sensor and the sensor holder.



Type	Sensor OD (mm)	Sensor holder ID (mm)
EVA IN sensor	Ø 6	Ø 6.8
EVA OUT sensor	Ø 7	Ø 7.8

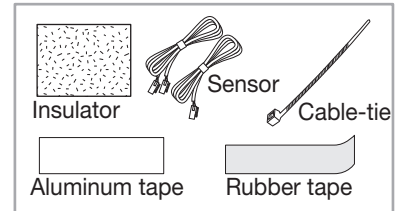

### 2) Put the sensor on the pipe.



#### Sensor attachment method.

- Choose the location where temperature can be measured correctly. (Refer to page 16)
- Try to attach closely to the contact surface.
- Do not use the sensor holder.

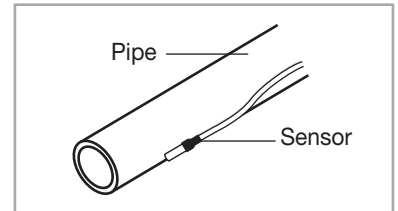

### 3) Hold the sensor and put aluminum tape around to fix the sensor.

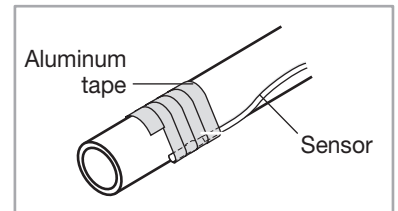

### 4) Put rubber tape around the sensor.

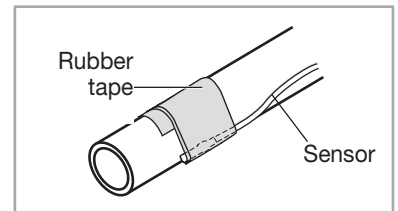

### 5) Use cable-tie to tighten the sensor around the pipe.

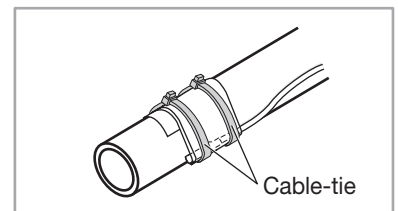

### 6) Attach the insulator around the sensor.

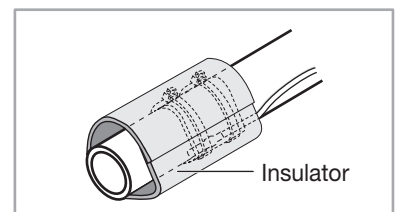

# FUNCTION SETTING

## Setting an indoor unit address and installation option

- ▶ Set the indoor unit address and installation option with remote controller option.  
Set the each option separately since you cannot set the ADDRESS setting and indoor unit installation setting option at the same time. You need to set twice when setting indoor unit address and installation option.
- ▶ The reception part of a remote controller is built in the AHU KIT PBA.

### The procedure of option setting

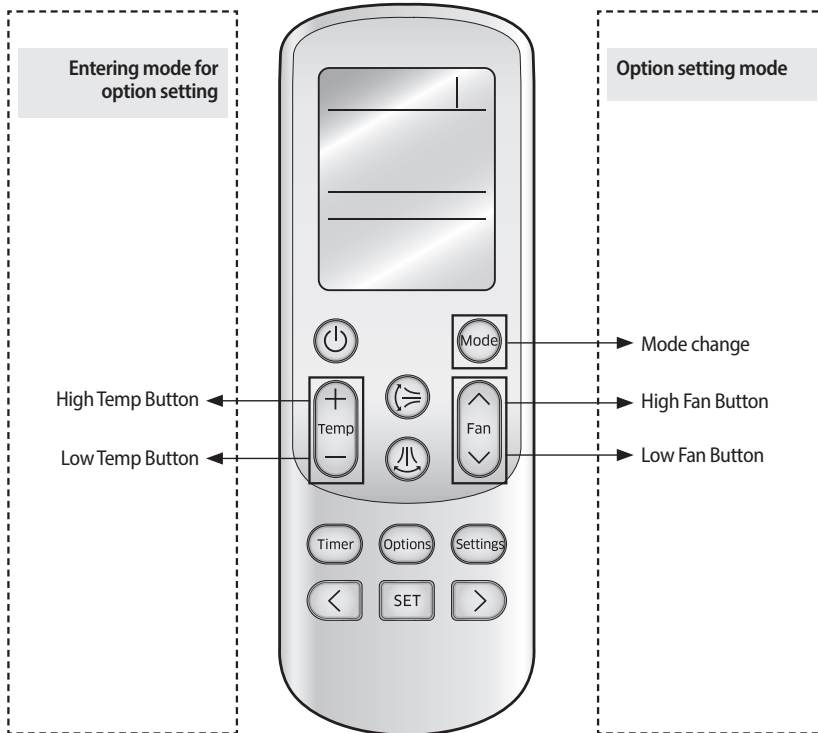

#### Step 1. Entering mode to set option

1. Remove batteries from the remote controller.
2. Insert batteries while pressing High Temp button and Low temp button to enter the option setting mode.



3. Check if you have entered the option setting status.

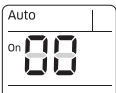

#### Step 2. The procedure of option setting

After entering the option setting status, select the option as listed below.



Option setting is available from SEG1 to SEG 24

- SEG1, SEG7, SEG13, SEG19 are not set as page option.
- Set the SEG2~SEG6, SEG8~SEG12 as ON status and SEG14~18, SEG20~24 as OFF status.



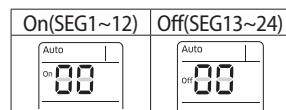

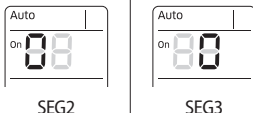
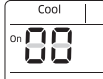
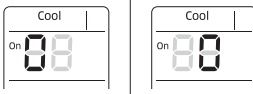
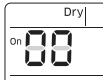
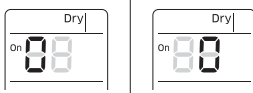
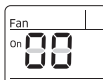
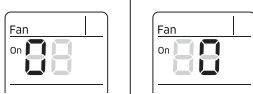
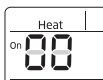
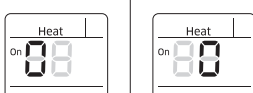
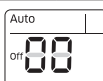
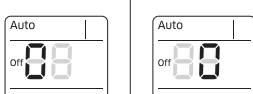
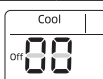

SEG1	SEG2	SEG3	SEG4	SEG5	SEG6	SEG7	SEG8	SEG9	SEG10	SEG11	SEG12
0	X	X	X	X	X	1	X	X	X	X	X
SEG13	SEG14	SEG15	SEG16	SEG17	SEG18	SEG19	SEG20	SEG21	SEG22	SEG23	SEG24
2	X	X	X	X	X	3	X	X	X	X	X

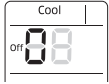
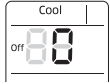

◀ **FUNCTION SETTING** (Continued)

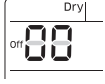
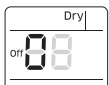
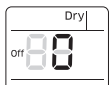
Option setting	Status
<p>1. Setting SEG2, SEG3 option                      Press Low Fan button(∨) to enter SEG2 value.                      Press High Fan button(∧) to enter SEG3 value.                      Each time you press the button,  →  → ...  →  will be selected in rotation.</p>	 <p>SEG2      SEG3</p>
<p>2. Setting Cool mode   Press Mode button to be changed to Cool mode in the ON status.</p>	
<p>3. Setting SEG4, SEG5 option                      Press Low Fan button(∨) to enter SEG4 value.                      Press High Fan button(∧) to enter SEG5 value.                      Each time you press the button,  →  → ...  →  will be selected in rotation.</p>	 <p>SEG4      SEG5</p>
<p>4. Setting Dry mode   Press Mode button to be changed to DRY mode in the ON status.</p>	
<p>5. Setting SEG6, SEG8 option                      Press Low Fan button(∨) to enter SEG6 value.                      Press High Fan button(∧) to enter SEG8 value.                      Each time you press the button,  →  → ...  →  will be selected in rotation.</p>	 <p>SEG6      SEG8</p>
<p>6. Setting Fan mode   Press Mode button to be changed to FAN mode in the ON status.</p>	
<p>7. Setting SEG9, SEG10 option                      Press Low Fan button(∨) to enter SEG9 value.                      Press High Fan button(∧) to enter SEG10 value.                      Each time you press the button,  →  → ...  →  will be selected in rotation.</p>	 <p>SEG9      SEG10</p>
<p>8. Setting Heat mode   Press Mode button to be changed to HEAT mode in the ON status.</p>	
<p>9. Setting SEG11, SEG12 option                      Press Low Fan button(∨) to enter SEG11 value.                      Press High Fan button(∧) to enter SEG12 value.                      Each time you press the button,  →  → ...  →  will be selected in rotation.</p>	 <p>SEG11      SEG12</p>
<p>10. Setting Auto mode   Press Mode button to be changed to AUTO mode in the OFF status.</p>	
<p>11. Setting SEG14, SEG15 option                      Press Low Fan button(∨) to enter SEG14 value.                      Press High Fan button(∧) to enter SEG15 value.                      Each time you press the button,  →  → ...  →  will be selected in rotation.</p>	 <p>SEG14      SEG15</p>
<p>12. Setting Cool mode   Press Mode button to be change to Cool mode in the OFF status.</p>	

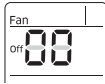
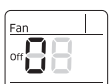
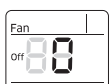
## ◀ FUNCTION SETTING (Continued)

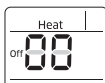
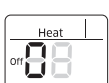
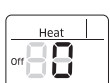
Option setting	Status
1. Setting SEG16, SEG17 option Press Low Fan button(∨) to enter SEG16 value. Press High Fan button(∧) to enter SEG17 value. Each time you press the button,  →  → ...  →  will be selected in rotation.	  SEG16                      SEG17
2. Setting Dry mode  Press Mode button to be change to Dry mode in the OFF status.	
3. Setting SEG18, SEG20 option Press Low Fan button(∨) to enter SEG18 value. Press High Fan button(∧) to enter SEG20 value. Each time you press the button,  →  → ...  →  will be selected in rotation.	  SEG18                      SEG20
4. Setting Fan mode  Press Mode button to be change to Fan mode in the OFF status.	
5. Setting SEG21, SEG22 option Press Low Fan button(∨) to enter SEG21 value. Press High Fan button(∧) to enter SEG22 value. Each time you press the button,  →  → ...  →  will be selected in rotation.	  SEG21                      SEG22
6. Setting Heat mode  Press Mode button to be change to HEAT mode in the OFF status.	
7. Setting SEG23, SEG24 mode Press Low Fan button(∨) to enter SEG23 value. Press High Fan button(∧) to enter SEG24 value. Each time you press the button,  →  → ...  →  will be selected in rotation.	  SEG23                      SEG24

### Step 3. Check the option you have set

After setting option, press  button to check whether the option code you input is correct or not.

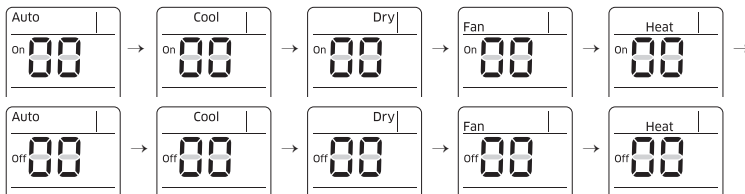

### Step 4. Input option

Press operation button  with the direction of remote control for set.  
 For the correct option setting, you must input the option twice.

### Step 5. Check operation

- 1) Reset the indoor unit by pressing the RESET button of indoor unit or outdoor unit.
- 2) Take the batteries out of the remote controller and insert them again and then press the operation button.

### Setting an indoor unit address (MAIN/RMC)

1. Check whether power is supplied or not.
  - When the indoor unit is not plugged in, there should be additional power supply in the indoor unit.
2. The reception part of a remote controller is built in the AHU KIT PBA.
3. Before installing the indoor unit, assign an address to the indoor unit according to the air conditioning system plan.
4. Assign an indoor unit address by wireless remote controller.
  - The initial setting status of indoor unit ADDRESS(MAIN/RMC) is "0A0000-100000-200000-300000".

Option No. : 0AXXXX-1XXXX-2XXXX-3XXXX

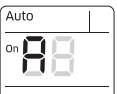
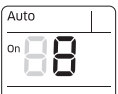
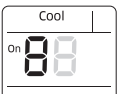
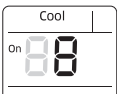
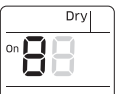
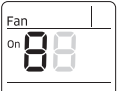
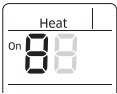
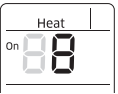
Option	SEG1		SEG2		SEG3		SEG4		SEG5		SEG6	
Explanation	PAGE		MODE		Setting Main address		100-digit of indoor unit address		10-digit of indoor unit		The unit digit of an indoor unit	
Remote Controller Display												
Indication and Details	Indication	Details	Indication	Details	Indication	Details	Indication	Details	Indication	Details	Indication	Details
	0		A		0	No Main address	0~9	100-digit	0~9	10-digit	0~9	A unit digit
				1	Main address setting mode							
Option	SEG7		SEG8		SEG9		SEG10		SEG11		SEG12	
Explanation	PAGE		-		Setting RMC address		-		Group channel(*16)		Group address	
Remote Controller Display												
Indication and Details	Indication	Details	-		Indication	Details	-		Indication	Details	Indication	Details
	1				0	No RMC address			RMC1	0~2	RMC2	0~F
					1	RMC address setting mode						



- When "A"~"F" is entered to SEG5~6, the indoor unit MAIN ADDRESS is not changed.
- If you set the SEG 3 as 0, the indoor unit will maintain the previous MAIN ADDRESS even if you input the option value of SEG5~6.
- If you set the SEG 9 as 0, the indoor unit will maintain previous RMC ADDRESS even if you input the option value of SEG11~12.

**Setting an indoor unit installation option (suitable for the condition of each installation location)**

1. Check whether power is supplied or not.
  - When the indoor unit is not plugged in, there should be additional power supply in the indoor unit.
2. The reception part of a remote controller is built in the AHU KIT PBA.
3. Set the installation option according to the installation condition of an air conditioner.
  - The default setting of an indoor unit installation option is "020010-100000-200000-300000"
4. Set the indoor unit option by wireless remote controller.

**■ 02 series installation option**

SEG1	SEG2	SEG3	SEG4	SEG5	SEG6
0	2	-	External room temperature sensor / Minimizing fan operation when thermostat is off	Central control	-
SEG7	SEG8	SEG9	SEG10	SEG11	SEG12
1	-	Hot water heater	-	EEV Step when heating stops	-
SEG13	SEG14	SEG15	SEG16	SEG17	SEG18
2	External control	External control output / External heater On or Off signal	-	Buzzer	-
SEG19	SEG20	SEG21	SEG22	SEG23	SEG24
3	-	Heating setting compensation	EEV Step of stopped unit during oil return / defrost mode	-	-

- ▶ When setting the option other than above SEG values, the option will be set as "0".
- ▶ SEG5 central control option is basically set as 1 (Use), so you don't need to set the central control option additionally. However, if the central control is not connected but it doesn't indicate an error message, you need to set the central control option as 0 (Disuse) to exclude the indoor unit from the central control.

Option No.: 02XXXX-1XXXXX-2XXXXX-3XXXXX

Option	SEG1	SEG2	SEG3	SEG4	SEG5	SEG6		
Explanation	PAGE	MODE	-	Use of external room temperature sensor / Minimizing fan operation when thermostat is off	Use of central control	-		
Remote Controller Display	-		-			-		
Indication and Details	Indication	Details	-	Indication	Details		Indication	Details
	0	2			0	Disuse		
	1			1	Use	1	Use	
	2			2	Disuse			
	3			3	Use			
	4			4	Disuse			
	5			5	Use			
	6			6	Disuse			
7		7	Use					

## ◀ FUNCTION SETTING (Continued)

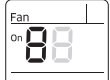
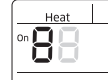
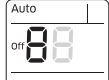
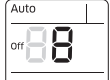
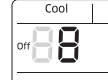
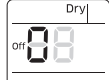
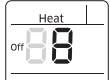
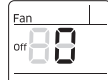
Option	SEG7	SEG8	SEG9	SEG10	SEG11	SEG12			
Explanation	PAGE	-	Use of hot water heater	-	EEV Step when heating stops	-			
Remote Controller Display	-								
Indication and Details	Indication	-	Indication	-	Indication	-			
	Details		Details		Details				
	1		0		Disuse		0	Default value	
			1		Use <sup>(*)2</sup>		1	Noise decreasing setting	
			2	-					
			3	Use <sup>(*)2</sup>					
Option	SEG13	SEG14	SEG15	SEG16	SEG17	SEG18			
Explanation	PAGE	Use of external control	Setting the output of external control / External heater On/Off signal	-	Buzzer control	Number of hours using filter			
Remote Controller Display	-								
Indication and Details	Indication	Indication	Indication	-	Indication	Indication			
	Details	Details	Details		Details	Details	Details		
	2	0	Disuse		Setting the output of external control	External heater On/Off signal	0	Use buzzer	
					0	Thermo on	-	2	1000 Hour
		1	ON/OFF Control		1	Operation on	-	1	Disuse buzzer
			2	-	Use <sup>(*)3</sup>	6	2000 Hour		
		2	OFF Control	3	-	Use <sup>(*)3</sup>			
Option	SEG19	SEG20	SEG21	SEG22	SEG23	SEG24			
Explanation	PAGE	-	Heating setting compensation	EEV opening of an indoor unit stopped during oil return or defrost operation.	-	-			
Remote Controller Display	-								
Indication and Details	Indication	-	Indication	-	Indication	-			
	Details		Details		Details				
	3		0		Disuse		0	Default value	
			1		2 °C		1	Oil return or Noise decreasing in defrost mode	
		2	5 °C						
		-	-						

<sup>(\*)1</sup> Minimizing fan operation when thermostat is off

- Fan operates for 20 seconds at an interval of 5 minutes in heating mode.
- Fan stops when thermostat is off in cooling mode.
- Make sure to connect the wired remote controller or the external room temperature sensor if you use the function of external room temperature sensor or minimizing fan operation. (In order to implement the functions the option of using temperature sensor inside the wired remote controller must be set. Refer to the installation manual of the wired remote controller.

<sup>(\*)2</sup> 1: Fan is turned on continually when the hot water heater is turned on,

3: Fan is turned off when the hot water heater is turned on with cooling only indoor unit

Cooling only indoor unit: To use this option, install the Mode Select switch (MCM-C200) on the outdoor unit and fix it as cool mode.

<sup>(\*)3</sup> When the following 2 or 3 is used as external heater On/Off signal, the signal for monitoring external contact control will not be output.

2: Fan is turned on continually when the external heater is turned on,

3: Fan is turned off when the external heater is turned on with cooling only indoor unit

Cooling only indoor unit: To use this option, install the Mode Select switch (MCM-C200) on the outdoor unit and fix it as cool mode.

- ▶ If Fan is set to off for cooling only indoor unit by setting the SEG9=3 or SEG15=3, you need to use an external sensor or wired remote controller sensor to detect indoor temperature exactly.



◀ FUNCTION SETTING (Continued)

■ 05 series installation option

SEG1	SEG2	SEG3	SEG4	SEG5	SEG6
0	5	Use of Auto Change Over for HR only in Auto mode	(When setting SEG3)Standard heating temp. Offset	(When setting SEG3)Standard cooling temp. Offset	(When setting SEG3)Standard for mode change Heating → Cooling
SEG7	SEG8	SEG9	SEG10	SEG11	SEG12
1	(When setting SEG3) Standard for mode change Cooling → Heating	(When setting SEG3) Time required for mode change	Compensation option for Long pipe or height difference between indoor units	MTFC	-
SEG13	SEG14	SEG15	SEG16	SEG17	SEG18
2	-	-	-	Temperature control by using simple BMS	Control variables when using hot water/external heater
SEG19	SEG20	SEG21	SEG22	SEG23	SEG24
3	AHU Kit capacity setting	Fan Feedback	Defrost Signal	Skip the prevention of cold air	-

■ 05 series installation option(Detailed)

Option No. : 05XXXX-1XXXXX-2XXXXX-3XXXXX

Option	SEG1	SEG2	SEG3	SEG4	SEG5	SEG6				
Explanation	0	5	Use of Auto Change Over for HR only in Auto mode	(When setting SEG3) Standard heating temp. Offset	(When setting SEG3) Standard cooling temp. Offset	(When setting SEG3) Standard for mode change Heating → Cooling				
Remote Controller Display	-									
Indication and Details	-	-	Indication	Details	Indication	Details	Indication	Details	Indication	Details
			0	Follow product option	0	0	0	0	0	1
			1	Use Auto Change Over for HR only	1	0.5	1	0.5	1	1.5
					2	1	2	1	2	2
					3	1.5	3	1.5	3	2.5
					4	2	4	2	4	3
					5	2.5	5	2.5	5	3.5
					6	3	6	3	6	4
7	3.5	7	3.5	7	4.5					
Option	SEG7	SEG8	SEG9	SEG10	SEG11	SEG12				
Explanation	1	(When setting SEG3) Standard for mode changing Cooling → Heating mode	(When setting SEG3) Time required for mode change	Compensation option for Long pipe or height difference between indoor units	MTFC	-				
Remote Controller Display	-									
Indication and Details	-	-	Indication	Details	Indication	Details	Indication	Details	-	-
			0	1	0	5 min.	0	Use default value		
			1	1.5	1	7 min.	1	1) Height difference <sup>(1)</sup> is more than 30 m or 2) Distance <sup>(2)</sup> is longer than 110 m		
			2	2	2	9 min.				
			3	2.5	3	11 min.				
			4	3	4	13 min.	2	1) Height difference <sup>(1)</sup> is 15 ~ 30 m or 2) Distance <sup>(2)</sup> is 50 ~ 110 m		
			5	3.5	5	15 min.				
			6	4	6	20 min.				
7	4.5	7	30 min.							
Option	SEG13	SEG14	SEG15	SEG16	SEG17	SEG18 <sup>(*)</sup>				

◀ FUNCTION SETTING (Continued)

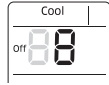
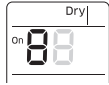
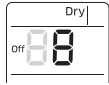
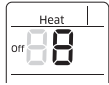
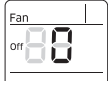
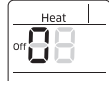
Explanation	-	-	-	-	Temperature control by using simple BMS	Control variables when using hot water / external heater			
Remote Controller Display									
Indication and Details	-	-	-	-	Indication	Details	Details		
							Indication	Set temp. for heater On/Off	Delay time for heater On
					0	Room temperature	0	At the same time as thermo on	No delay
							1	At the same time as thermo on	10 minutes
							2	At the same time as thermo on	20 minutes
							3	1.5 °C(2.7 °F)	No delay
							4	1.5 °C(2.7 °F)	10 minutes
							5	1.5 °C(2.7 °F)	20 minutes
					1	Discharge temperature	6	3.0 °C(5.4 °F)	No delay
							7	3.0 °C(5.4 °F)	10 minutes
							8	3.0 °C(5.4 °F)	20 minutes
							9	4.5 °C(8.1 °F)	No delay
							A	4.5 °C(8.1 °F)	10 minutes
							B	4.5 °C(8.1 °F)	20 minutes
C	6.0 °C(10.8 °F)	No delay							
D	6.0 °C(10.8 °F)	10 minutes							
E	6.0 °C(10.8 °F)	20 minutes							
Option	SEG19	SEG20	SEG21	SEG22	SEG23	SEG24			
Explanation	PAGE	AHU Kit capacity setting	Fan Feedback	Defrost Signal	Skip the prevention of cold air	-			
Remote Controller Display	-								
Indication and Details	3	Indication	Details	Indication	Details	Indication	Details	Indication	Details
		0	Default	0	Disuse	0	Disuse	0	Disuse
		1	Default x 1	1	use	1	Defrost valve	1	use
		2	Default x 2	-		2	Defrost signal	-	
		3	Default x 3	-		-		-	
4	Default x 4	-		-		-			

<sup>(\*)</sup> Height difference : The difference of the height between the corresponding indoor unit and the indoor unit installed at the lowest place.  
For example, When the indoor unit is installed 40 m higher than the indoor unit installed at the lowest place, select the option "1".

<sup>(\*)</sup> Distance : The difference between the pipe length of the indoor unit installed at farthest place from an outdoor unit and the pipe length of the corresponding indoor unit from an outdoor unit.  
For example, when the farthest pipe length is 100 m and the corresponding indoor unit is 40 m away from an outdoor unit, select the option "2". (100 - 40 = 60 m)

<sup>(\*)</sup> Heater operation when the SEG9 of 02 series installation option is set to using hot water heater or when SEG15 is set to using external heater

e.g. 1) Setting 02 series SEG9 = "1" / Setting 05 series SEG18 = "0": Hot water heater is turned on at the same time as the heating thermostat is on, and turned off when the heating thermostat is off.

e.g. 2) Setting 02 series SEG15 = "2" / Setting 05 series SEG18 = "A":

Room temp. ≤ set temp. + f(heating compensation temp.)

- External heater is turned on when the temperature is maintained as 4.5 °C(8.1 °F) for 10 minutes.

Room temp. > set temp. + f(heating compensation temp.)

- External heater is turned off when the temperature is maintained as 4.5 °C(8.1 °F) + 1 °C(1.8 °F) [1 °C(1.8 °F) is the Hysteresis for On/Off selection.]

## ◀ FUNCTION SETTING (Continued)

### SEG 3, 4, 5, 6, 8, 9 additional information

When the SEG 3 is set as "1" and follow Auto Change Over for HR only operation, it will operate as follows.

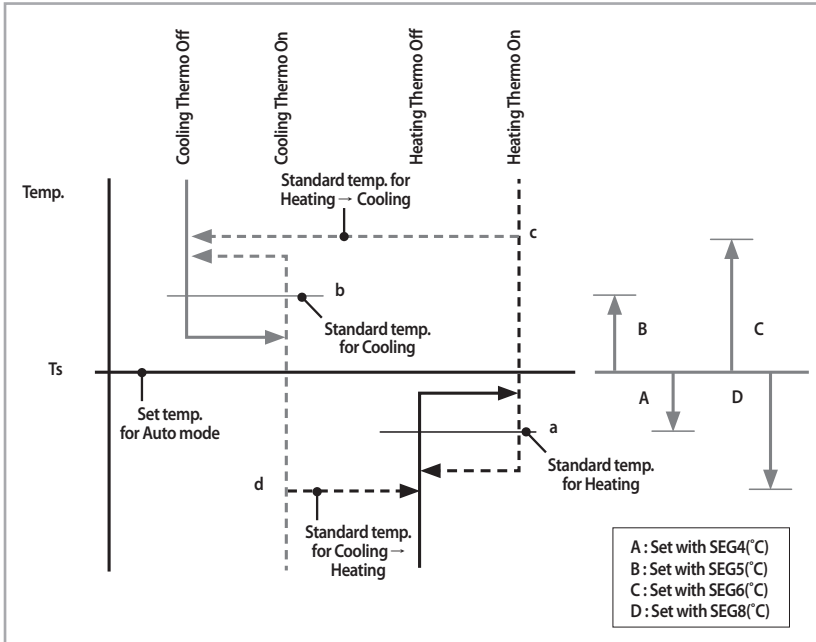

Cooling/Heating mode can be changed when Thermo Off status is maintained during the time with SEG9.

## Changing a particular option

You can change each digit of set option.

Option	SEG1	SEG2	SEG3	SEG4	SEG5	SEG6
Explanation	PAGE	MODE	The option mode you want to change	The tens' digit of an option SEG you will change	The unit digit of an option SEG you will change	Changed value
Remote Controller Display		Auto on 88	Auto on 88	Cool on 88	Cool on 88	Dry on 88
Indication and Details	Indication	Indication	Indication	Indication	Indication	Indication
	Details	Details	Details	Details	Details	Details
	0	D	Option mode 1~6	Tens' digit of SEG 0~9	Unit digit of SEG 0~9	The changed value 0~F

- Note**
- When changing a digit of an indoor unit address setting option, set the SEG3 as 'A'.
  - When changing a digit of indoor unit installation option, set the SEG3 as '2'.

**Ex) When setting the 'buzzer control' into disuse status.**

Option	SEG1	SEG2	SEG3	SEG4	SEG5	SEG6
Explanation	PAGE	MODE	The option mode you want to change	The tens' digit of an option SEG you will change	The unit digit of an option SEG you will change	Changed value
Indication	0	D	2	1	7	1

# TROUBLESHOOTING

## Initial Check-up

- 1) Check the connection status between Indoor unit and the AHU-KIT.
  - Make sure you have followed instructions and wiring diagram shown in the installation manual.
  - Make sure AHU-KIT PBA is installed in a place where there are no influence from outdoor humidity, dust and temperature.
- 2) Ensure that power voltage is AC 187V~AC 253V.
- 3) Check each of the accessories and make sure they are in good condition.
  - CN32 : DC 11~13V (both ends)
  - IC02 G/O : DC 4.5~5.5V (both ends)
  - TRANS Output : AC 16~18V

## EEPROM Error

Outdoor unit display	<i>E162</i>
Explanation	Internal communication error between EEPROM and MICOM
Reason	Require to change PBA due to Bad EEPROM



- Wired remote controller will show the same error shown in the outdoor unit.

## Sensor Error

### AHU-KIT heat exchanger EVA IN sensor detachment error

Outdoor unit display	<b>E128</b> → <b>A<sup>xxx</sup></b> (xxx : Address of an indoor unit with an error)
Explanation	Refer to below explanation.
Reason	Indoor heat exchanger EVA IN sensor detachment.

#### 1) Explanation

- When testing run in Cool mode (Please, press the button for the test run inside the outdoor unit)

Tcond, out-Tair, out > 3°C	OK
Tair, in-Teva, in > 4°C	NO
Tair, in-Teva, out > 4°C	OK
Compressor, Indoor unit in operation. Thermo ON	OK
Error message	Indoor heat exchanger EVA IN sensor detachment error

- When conditions shown in above table occurs, it is classified as **E128**→**A<sup>xxx</sup>**

#### 2) Self check

- Check for EVA IN sensor of AHU-KIT heat exchanger. Make sure it is in the correct location.

### AHU-KIT heat exchanger EVA OUT sensor detachment error

Outdoor unit display	<b>E129</b> → <b>A<sup>xxx</sup></b> (xxx : Address of an indoor unit with an error)
Explanation	Refer to below explanation.
Reason	Indoor heat exchanger EVA OUT sensor detachment.

#### 1) Explanation

- When testing run in Cool mode (Please, press the button for the test run inside the outdoor unit)

Tcond, out-Tair, out > 3°C	OK
Tair, in-Teva, in > 4°C	OK
Tair, in-Teva, out > 4°C	NO
Compressor, Indoor unit in operation. Thermo ON	OK
Error message	Indoor heat exchanger EVA OUT sensor detachment error

- When conditions shown in above table occurs, it is classified as **E129**→**A<sup>xxx</sup>**

#### 1) Self check

- Check for AHU-KIT heat exchanger EVA OUT sensor. Make sure it is in the correct location.



- Wired remote controller will show the same error shown in the outdoor unit.

## AHU-KIT temperature sensor OPEN/SHORT error

Outdoor unit display	<i>E421</i> (ROOM sensor OPEN/SHORT) <i>E422</i> (EVA IN sensor OPEN/SHORT) <i>E423</i> (EVA OUT sensor OPEN/SHORT) <i>E426</i> (Disch. sensor OPEN/SHORT)
Explanation	When OPEN/SHORT signal is received for temperature sensor of AHU-KIT
Reason	Poor connection between sensor and the PBA, or poor conditioned sensor.

### 1) Self check

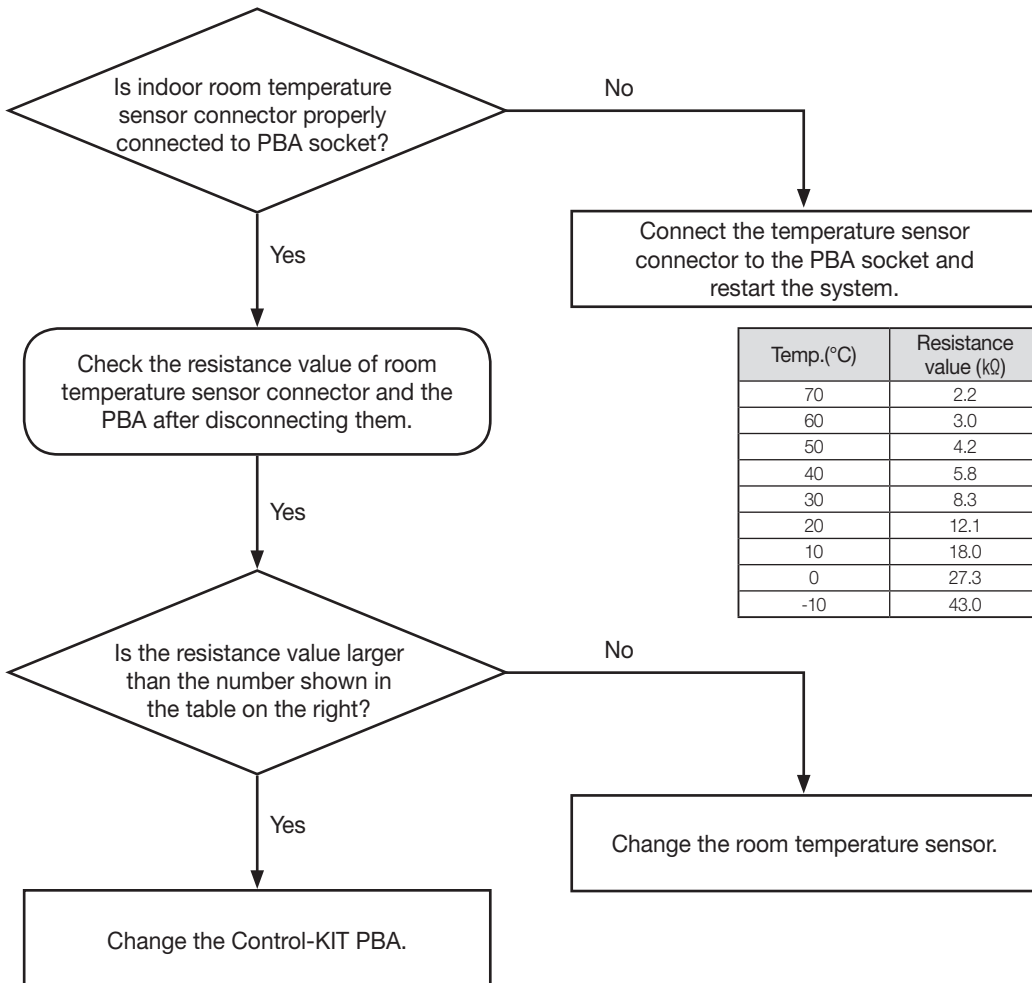

**Note**

- Wired remote controller will show the same error shown in the outdoor unit.

## Fan Error

Outdoor unit display	<b>E154</b>
Explanation	When Control-KIT outputs fan operation status signal and the fan feedback signal stays OPEN for more than 10 seconds. ( AHU-KIT only)
Reason	<ul style="list-style-type: none"> <li>• Poor AHU fan operation</li> <li>• Missing or Incorrect circuit system for fan feedback check.</li> </ul>

### 1) Self check

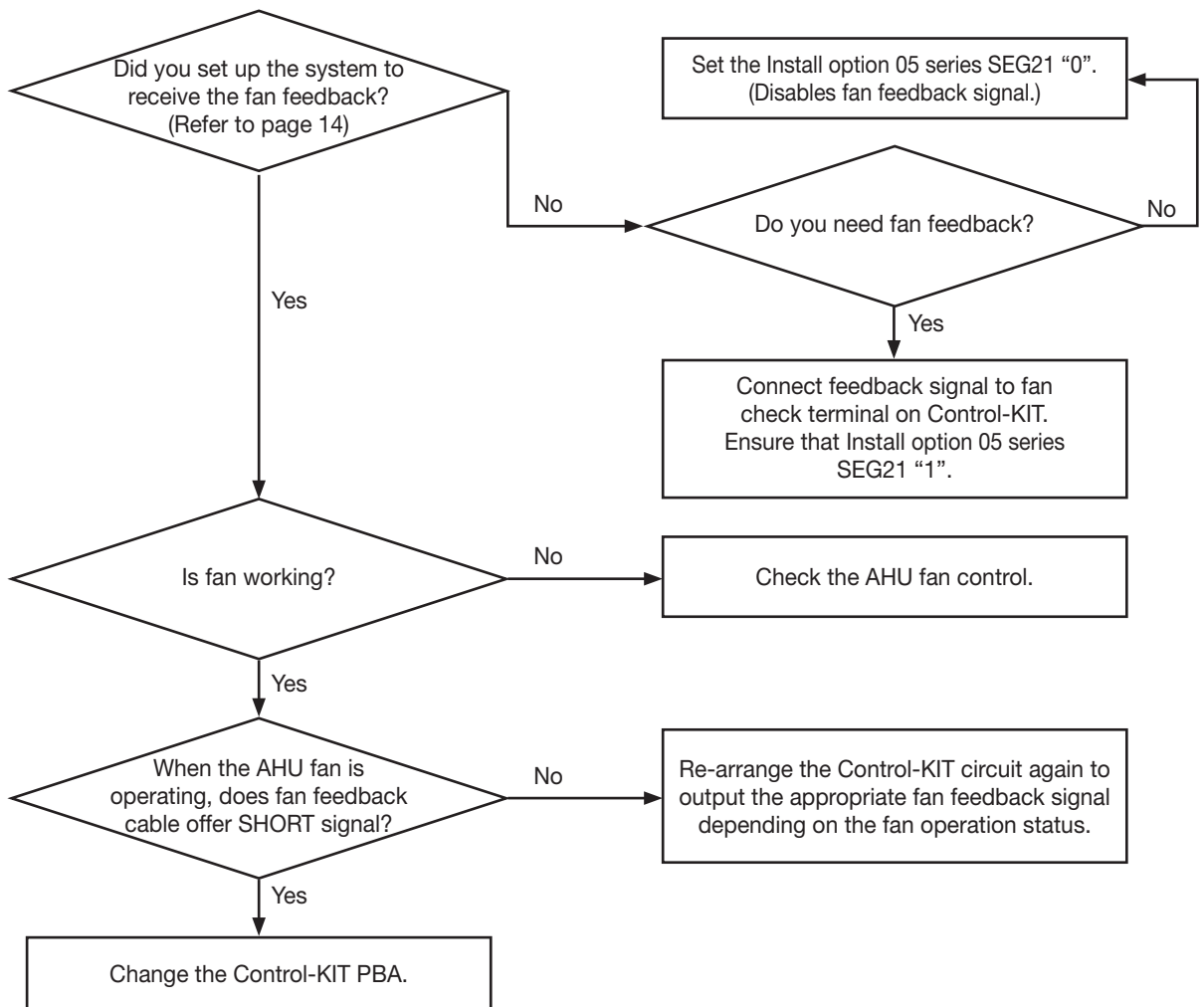

- Fan feedback check terminal should only receive OPEN/SHORT contact signal without voltage. When the fan feedback check terminal receives contact signal with voltage may damage the Control-KIT .

## How to Inspect Just in Case the Below Condition is Satisfied

Outdoor unit display	N/A
Explanation	In Cool mode, Min.100 and Max.480 EEV steps can be controlled. In Heat mode, Min 250 EEV steps can be controlled.
Reason	<ul style="list-style-type: none"> <li>• Inappropriate EVA IN/OUT sensor location</li> <li>• Reversed EEV coil installation</li> <li>• All or part of the EEV coil detachment</li> <li>• Excessive additional refrigerant.</li> </ul>

### 1) Self check

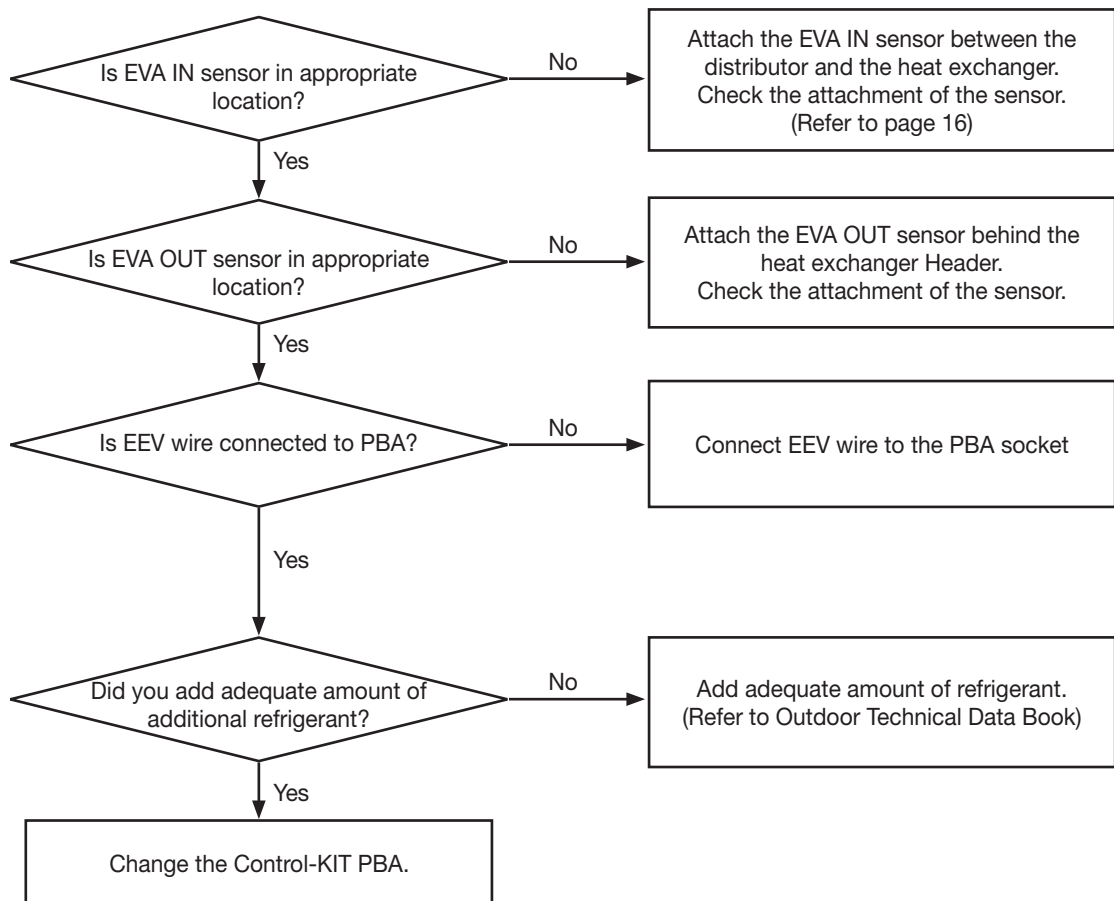



## In-tracking Error

### Error between AHU-KIT and outdoor unit at the beginning of operation(in tracking)

Outdoor unit display	<i>E201</i>
Explanation	Communication error between AHU-KIT and the outdoor unit
Reason	Refer to following self check

#### 1) Self check

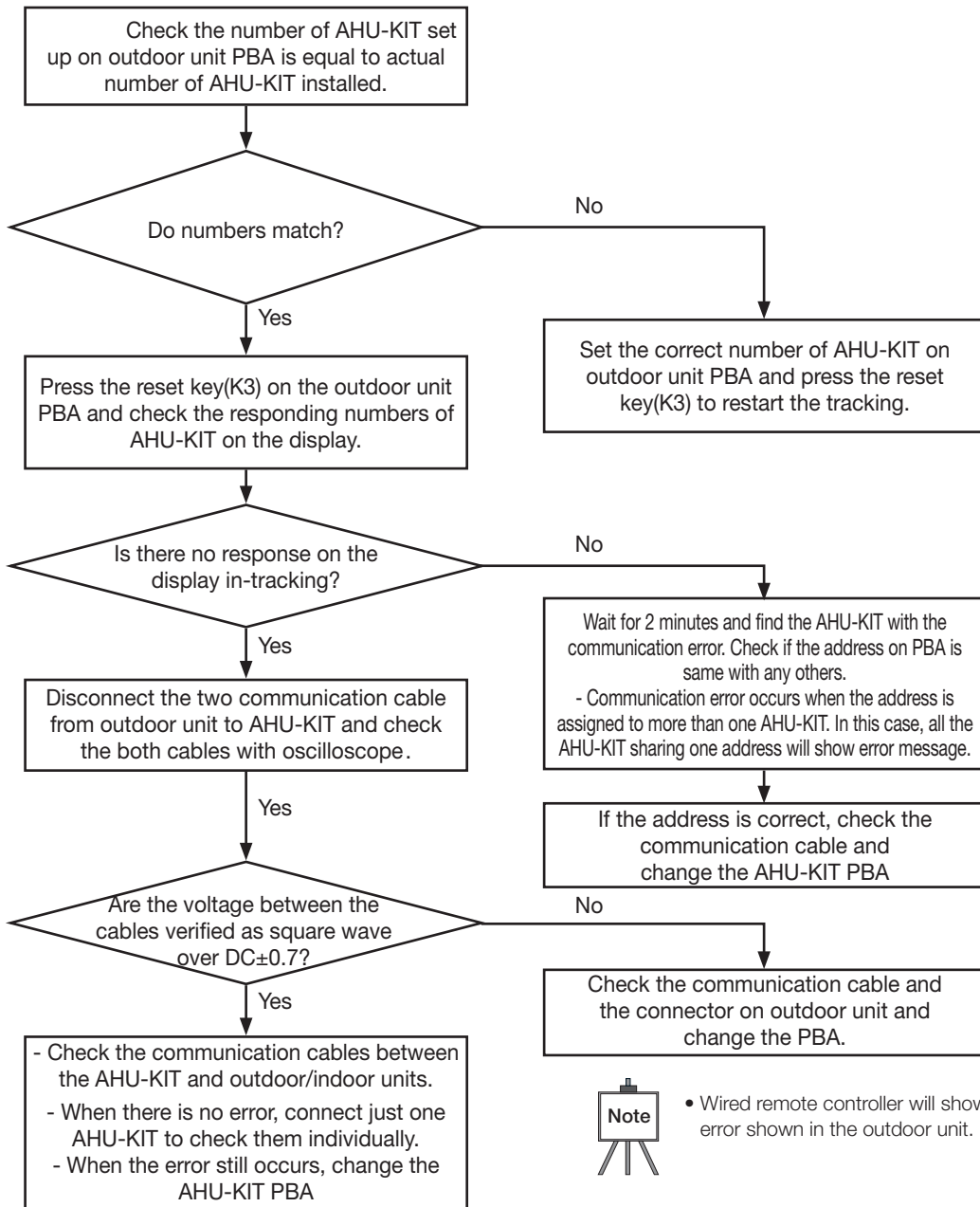

### Error between AHU-KIT and outdoor unit during operation(after tracking)

Outdoor unit display	<b>E202</b>
Explanation	Communication is off for 2 minutes between AHU-KIT and the outdoor unit during operation. (Ensure room)
Reason	Communication error between AHU-KIT and the outdoor or incorrect AHU-KIT number setting

#### 1) Self check

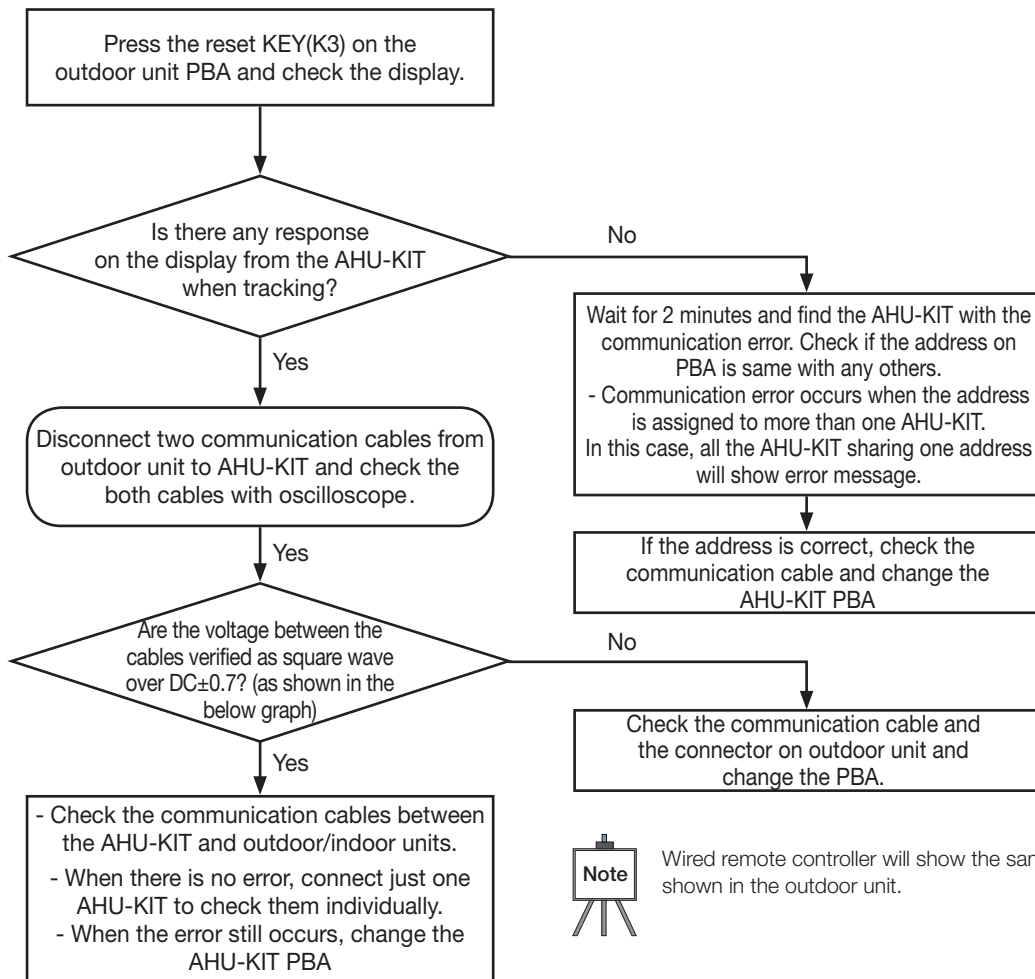

Wired remote controller will show the same error shown in the outdoor unit.

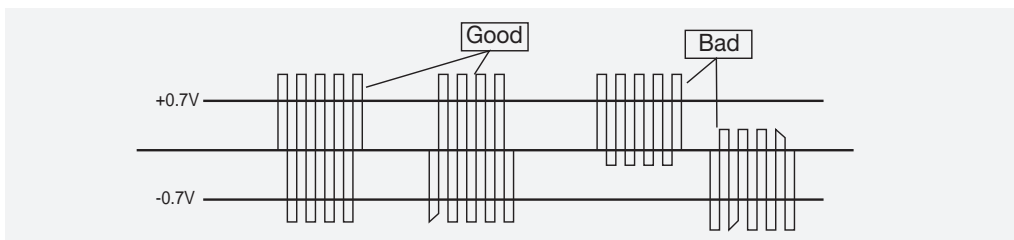

## AHU-KIT Installation Check

### 1) Ensure that Control-KIT is correctly installed.

- You can choose the built-in type or auxiliary type depending on installation environment.
- Ensure that the Control-KIT cables are correctly connected.
- Control-KIT should be fireproofed and avoid direct sunlight upon installation.  
(Especially for individual type)
- Avoid installing the unit in a location exposed to direct sunlight or rain.
- Do not install the Control-KIT in or on the outdoor unit.

### 2) Ensure that EEV-KIT is correctly installed.

- Ensure that EEV-KIT can be installed inside or outside, but do not install the EEV-KIT in residential areas.
- When EEV-KIT is installed separately outside of the AHU, insulate the pipe to prevent the dew condensate.
- Ensure that IN/OUT pipes are correctly connected.
- Ensure that the body of EEV-KIT is installed in level.
- Make sure that EEV-KIT is installed where condensation can be drained well.
- Do not install the EEV-KIT in or on the outdoor unit.

### 3) Ensure that EVA IN/OUT sensor is correctly attached.

- EVA IN sensor should be attached after the distributor, on the coldest part of the heat exchanger piping.  
Ensure that the sensor is insulated.
- EVA OUT sensor should be installed approximately 200mm behind the header of AHU heat exchanger.

### 4) Ensure that Disch. sensor is correctly attached. (Optional)

- Disch. sensor should be located after heat exchanger (over 1m)
- Detail explanation of Disch. Temperature setting is on wired remote controller manual.  
(Installation manual, service mode)
- When using Disch. temperature control, change the product option code (01 series) SEG 21 "1".

## Test Operation

1) Before turning the power on, use DC 500V insulation tester to check the power terminal (L,N) and the earthing on AHU-KIT.

- Resistance value should be over  $30M\Omega$  .

2) Test the voltage of power(L, N) before turning on the power.



- Insulation tester may damage the communication circuit.
- Communication terminal should be tested with ordinary circuit tester to check the short circuit.

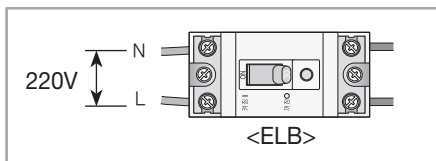

3) Check the list below after installation and make sure the AHU-KIT units are properly operating.

- Installation environment (resistance level etc.)
- Refrigerant leak test
- Power cable
- Insulation on refrigerant pipe.
- Drainage
- Circuit breaker connection and earthing
- Normal system operation





# MEMO

---

A series of horizontal dotted lines for writing.

**SAMSUNG**